

**“THE SERVICE MAN’S FRIEND”**

# **EQUIPMENT**



# **CATALOG**

---

*Serving the Lp Industry since 1954*

# ***PETROLEUM TANK CORP***

# ***PETROLEUM TANK CORP***

## **TERMS AND CONDITIONS OF SALE & WARRANTY**

### **IMPORTANT INFORMATION:**

Possession of this catalog does not constitute an offer to sell by PETCO, or the right to purchase from us.

### **TERMS**

All orders are accepted subject to credit approval. To customers with established credit our terms are Net 30 days from the date of the invoice. A late charge of 1 1/2% per month will be assessed on all past due accounts. No shipment will be made on open account to a customer whose account is past due.

If credit is not established all shipping will be COD. Any charges by the transportation company will be the responsibility of the buyers.

### **PRICING**

Prices are subject to change without notice. All orders will be billed at current prices on the date of shipment.

### **FREIGHT**

All shipments will be made via UPS or motor freight. All prices are FOB shipping point, which is normally our warehouse. Routing of shipments will be at the discretion of the seller, with no liability from the exercise of such discretion.

### **MINIMUM ORDER**

All orders are subject to a \$15.00 minimum.

### **DAMAGED SHIPMENTS**

Merchandise properly packaged and delivered to the freight carrier releases PETCO from all responsibility. Claims for damaged shipments are the responsibility of and must be filed by the consignee against the carrier.

### **RETURNS**

All returns must be approved in advance by PETCO management.

### **WARRANTY**

All warranty returns are subject to the manufacturer's warranty policy. In no case do we assume or admit liability for labor, damage, leakage, or other claims arising from defective goods. No liability is assumed beyond that of the manufacturer.

### **WARRANTY DISCLAIMER**

PETCO has made diligent effort to illustrate and describe the products in this catalog accurately; however, such illustrations and descriptions are for the sole purpose of identification, and do not express or imply a warranty that the products are merchantable, or fit for a particular purpose, or that the product will necessarily conform to the illustrations or descriptions. No warranty or affirmation of fact, express or implied, other than as set forth in the limited statement above is made or authorized by PETCO.

### **TAXES**

Any state and federal tax levied against the net price is an additional charge to be assessed and paid by the purchaser. In states requiring a resale license number, the buyer agrees to furnish his certificate number or other proof of license to buy without paying the applicable taxes to us.

### **DEBIT**

No debit memorandum will be accepted.

### **SPECIAL ORDERS**

Orders for special products, not considered by PETCO as a stocked product, are non-cancellable and non-returnable unless agreed to in advance by our supplier.

### **WARNING**

Installation, usage and maintenance of all products sold by PETCO must be done in compliance with the manufacturer's instructions and applicable federal, state and local standards, codes, regulations and laws. While PETCO attempts to assure that its products comply with such codes, it cannot guarantee compliance, and cannot be responsible for how the product is installed or used. Installation and maintenance should be done by qualified personnel. The products contained in this catalog are mechanical devices that will eventually become inoperative due to wear, corrosion, and other environmental conditions. Periodic maintenance and inspection are required to avoid serious injury and property damage.

Some of the products sold by PETCO are manufactured to store, transport, transfer and use flammable liquids and gases. These products and the material they handle must be handled by experienced and trained personnel. These personnel should use accepted industry and governmental safety procedures.

# PETROLEUM TANK CORP

## TABLE OF CONTENTS

-A-		-C-	
Accident Report Kits	77		
Adaptors		Caps	
Acme		Mechanical	30
Brass	20-22	Metal (Steel)	24
Steel	20-22	Relief Valve	19
Fork Lift	22	Campers Hose	16
Liquid Withdrawal	21, 22	Cathodic Protection	40
Low Pressure Test	42	Chain Hoist	80
QCC	17	Chains	
POL	15, 17, 22	Acme Cap	23
Adjustable Wrenches	79	Hose Reel	59
Air Mixers	37	Chock Blocks	73
Anchor Kits		Connectors	45, 76
Commercial Appliance Connector	45	Convex Mirrors	74, 75
Shield & Screw	76	Corrosion Detection	40
Annodes	40	Copper Tubing	43
Appliance Connectors		Couplings	
Commercial	45	Black Pipe	30, 31
Domestic	45	Brass	25
		CSST	53
-B-		Filler	22
Bobtail Trucks	84, 85	Mechanical	30
Back Check Valves	20	Pull-away	20
Ball Valves	36	Schedule 80	33
Booster Cables	77	Vapor	22
Boxes, Gas	17	Cranes	84
Brackets		Crane Service Truck	83
Regulator	23	Cylinders	37 - 39
Chock Block	73	Cylinder Valves	18
Brass Fittings		Cylinder Valve Removal Devices	40
Flare	11 - 15		
Pipe	24 - 28	-D-	
Bypass Valve	65	Decals	66 - 71
		Delivery Hoses	57
-C-		Delivery Valves	20 - 23
Cabinets, Dispensing	81	Delivery Valve Holster	23
Cable Assemblies		Dial Chambers	41
PTO	73	Dispensing Stations	81
Throttle	73	Dog Repellant	78
Caps		Drills	
Acme	21, 22, 24	Masonry	79
		Orifice	89

*Serving the LP Industry*

*Building Relationships*

*Since 1954*

*1-800-457-3826*

*is our utmost reward*

# ***PETROLEUM TANK CORP***

## **TABLE OF CONTENTS**

<b>-E-</b>		<b>-H-</b>	
<b>E-Track Straps</b>	<b>80</b>	<b>Hammers (Dead Blow)</b>	<b>79</b>
<b>Electronic Metering Systems</b>	<b>62 - 64</b>	<b>Hand Cleaner</b>	<b>76</b>
<b>Extend-a-Magnet</b>	<b>78</b>	<b>Hand Torch</b>	<b>76</b>
<b>Extend-a-Match</b>	<b>78</b>	<b>Hogtails, Copper</b>	<b>16</b>
<b>Extend-a-Mirror</b>	<b>78</b>	<b>Hogtails, Thermo-Plastic</b>	<b>16</b>
		<b>Hoist, Chain</b>	<b>80</b>
		<b>Holster, Nozzle</b>	<b>23</b>
<b>-F-</b>		<b>Hose Assemblies</b>	
<b>Filler Couplings</b>	<b>21, 22</b>	<b>Bulk Plant</b>	<b>57</b>
<b>Filler Extensions</b>	<b>23</b>	<b>Camping</b>	<b>16, 17</b>
<b>Filler Valves</b>	<b>23</b>	<b>Dispenser</b>	<b>57</b>
<b>Fire Extinguisher &amp; Bracket</b>	<b>73</b>	<b>Grill</b>	<b>16, 17</b>
<b>First Aid Kits</b>	<b>77</b>	<b>Portable Heat</b>	<b>16</b>
<b>Fittings</b>		<b>Truck Delivery</b>	<b>57</b>
<b>Acme</b>	<b>20 -22, 24</b>	<b>Smart Hose</b>	<b>57</b>
<b>Black Pipe</b>	<b>29 - 33</b>	<b>Hose End Swivel</b>	<b>23, 57</b>
<b>Brass</b>	<b>24 - 28</b>	<b>Hose Reels</b>	<b>58</b>
<b>CSST</b>	<b>52 - 56</b>	<b>Hose Reel Parts</b>	<b>58, 59</b>
<b>Flare</b>	<b>11 - 14</b>	<b>Hose Reel Guidearm</b>	<b>60</b>
<b>Pipe, Schedule 80</b>	<b>33 - 35</b>	<b>Hose Reel Guidearm Parts</b>	<b>61</b>
<b>POL</b>	<b>15, 17</b>		
<b>Polyethylene</b>		<b>-I-</b>	
<b>Mechanical</b>	<b>48 - 50</b>	<b>Information Pages</b>	<b>51, 85 - 91</b>
<b>Socket</b>	<b>46, 47</b>		
<b>Flaring Tools</b>	<b>44</b>	<b>-J-</b>	
<b>Flash Lights</b>	<b>77</b>	<b>J-Clips</b>	<b>43</b>
<b>Flexible Connectors</b>	<b>45</b>	<b>Jumper Cables</b>	<b>77</b>
		<b>-L-</b>	
<b>-G-</b>		<b>Leak Detector</b>	<b>44</b>
<b>Gas Boxes</b>	<b>17</b>	<b>Lights (Work)</b>	<b>72</b>
<b>Gas Leak Detectors</b>	<b>40</b>	<b>Lighters, Gas</b>	<b>75</b>
<b>Gas Matches</b>	<b>75</b>	<b>Lighting (Truck)</b>	<b>72</b>
<b>Gauges</b>			
<b>Float</b>	<b>41, 42</b>	<b>-M-</b>	
<b>Pressure</b>	<b>42</b>	<b>Magnet (Extend-a-Magnet)</b>	<b>78</b>
<b>Gauge Dials</b>		<b>Manometers</b>	<b>42</b>
<b>Gauge Dial Gaskets</b>	<b>41</b>	<b>Metallic Locating Tape</b>	<b>46</b>
<b>Gauge Dial Screws</b>	<b>41</b>		
<b>Glasses, Safety</b>	<b>78</b>		
<b>Gloves</b>	<b>79</b>		
<b>Grease</b>	<b>77</b>		

# ***PETROLEUM TANK CORP***

## **TABLE OF CONTENTS**

	<b>-M-</b>			<b>R-</b>
<b>Meters</b>				
Liquid Controls		61, 63		<b>Rain Suits</b> 78
Neptune (Truck & Dispensing)		61		<b>Ratchet Straps</b> 80
<b>Meter Registers</b>		62 - 64		<b>Reflective Triangles</b> 77
<b>Methanol</b>		44		<b>Regulators</b>
<b>Methanol Injectors</b>		44		Automatic 7
<b>Mirrors (Truck)</b>		74		1st Stage 8
<b>Multi-Valves</b>		18		2nd Stage 8, 9
	<b>-O-</b>			Compact 8 - 10
<b>O-Rings</b>		24		Cylinder 7
<b>Oil</b>				Integral 2-Stage 10
Machine		77		2 PSIG 9
Penetrating		78		High Pressure Adjustable 7
<b>OPD (Valves &amp; Connectors)</b>		18		Low Pressure 7 - 9
<b>Orifices</b>		89		Mounting Bracket 23
<b>Orifice Drills</b>		89		<b>Relief Valves</b>
	<b>-P-</b>			External 19
<b>Paint</b>		71		Internal 19
<b>Pigtails</b>				<b>Remote Shut-down (Truck)</b> 82
Copper		15		<b>Ring &amp; Chain Assemblies</b> 23
Thermoplastic		16		<b>Risers</b> 47
<b>Pipe</b>				
Black Pipe		32, 33		
CSST		51 - 56		
Schedule 80		35, 36		
Polyethylene		46		
<b>Pipe Dope</b>		44		
<b>Pipe Primer</b>		44		
<b>Pipe Tape</b>		44		
<b>Pipe Wrenches</b>		80		
<b>Piping Quick Disconnects</b>		45		
<b>Placards</b>		67, 69		
<b>Plastic Plugs &amp; Caps</b>		24		
<b>Polyethylene Piping</b>				
Fittings		46, 47		
Pipe		46		
Risers		47		
<b>PTO's</b>		72		
<b>PTO Shafts</b>		72		
<b>Pullaway Valves</b>		23		
<b>Pumps</b>		64 - 66		
				<b>-S-</b>
				<b>Safety Glasses</b> 78
				<b>Scales</b> 81
				<b>Spanner Wrenches</b> 24
				<b>Shutdown (Remote)</b> 82
				<b>Smart Hose</b> 57
				<b>Switches</b> 73
				<b>Swivel, Hose End</b> 23, 57
				<b>Swivel, Full Circle</b> 59
				<b>-T-</b>
				<b>Tanks</b>
				A/G, A/G-U/G 39
				Domestic 37 - 39
				Lids 39
				<b>Tank Cradles</b> 80

*Serving the LP Industry*

*Building Relationships*

*Since 1954*

1-800-457-3826

*is our utmost reward*

# PETROLEUM TANK CORP

## TABLE OF CONTENTS

-T-		-V-	
Tank Straps	80	Valves	
Tank Trailer	80	Back Check	20
Tape		Ball	36
Metal Detection	46	Bypass	65
Silicone	44	Cooker	37
Teflon	44	Chek-Lok	18
Underground Protection	46	Cylinder	18
Technical Information	86 - 91	Delivery	20, 23, 24
Tee Blocks	42	Excess Flow	20
Test Block & Gauge	42	Filler	18, 22, 23
Test Kit, Low Pressure	42	Flare	28
Tester, Cathodic	40	Fork Lift	18, 22
Tester, Gas Leak		Liquid Withdrawal	19
Thermometers	42	Motor Fuel	22
Thermoplastic Pigtailed	16	Multi-Valve	18
Thread Sealer	44	Pullaway	23
Tools		Relief	19
Adjustable Wrenches	79	Service	18, 19, 24
Flaring Tools	44	Vapor Withdrawal	22
Orifice Drills	89	Vent	19
Pipe Wrenches	80	Vise, Cylinder	40
Spanner Wrenches	24		
Tubing Benders	43, 44	-W-	
Tubing Cutters	43, 45	Washers, Gaskets, O-rings	24
Vise Grips	79	Wasp & Hornet Spray	78
Tool Boxes	74	Wire Terminal Kits	76
Trace Wire	46	Work Lights	72
Tubing		Wrenches	
Aluminum	43	Adjustable	79
Copper	43	Channel Locks	79
Tubing Benders	43, 44	Pipe	80
Tubing Cutters	43 - 44	Tank	40
		Spanner	24
-U-		Vise Grips	79
Underground Pipe Tape	46		
Universal Dial Kits	41		
-V-			
Valve Wrenches	40		

# PETROLEUM TANK CORP

## REGULATORS

### FIRST STAGE HIGH PRESSURE REGULATOR

The First Stage regulator is a regulator reducing the inlet pressure, coming from the withdrawal cylinder, to a medium level suitable to feed a second stage regulator consequently.



**CAV 984HP-04** COMPACT 1/4" FNPT INLET, 1/2" FNPT OUTLET, NO ADJUSTMENT FOR PSIG OUTLET ADJ. RANGE, 10 PSIG OUTLET PRESS., 1,000,000 BTU/HR



**CAV 988HP-05** FULL SIZE, POL INLET, 1/2" FNPT OUTLET, 8 TP 12 PSIG OUTLET ADJ. RANGE, 10 PSIG OUTLET PRESS., 2,100,000 BTU/HR

**CAV 988HP-06** FULL SIZE, POL INLET, 3/4" FNPT OUTLET, 8 TP 12 PSIG OUTLET ADJ. RANGE, 10 PSIG OUTLET PRESS., 2,250,000 BTU/HR

### SECOND STAGE LOW PRESSURE REGULATOR

The Second-stage regulator is a regulator reducing the pressure coming from a first stage regulator directly to the inlet pressure of the user appliance or to a medium pressure valve in case of installations with pressure governors



**CAV 988LP-03** COMPACT, 1/2" FNPT INLET, 1/2" FNPT OUTLET, 9-13" WC OUTLET ADJ. RANGE, 11"WC OUTLET PRESS., 800,000 BTU/HR

**CAV 998LP-22** FULL SIZE, 1/2" FNPT INLET, 1/2" FNPT OUTLET, 9-13" WC OUTLET ADJ. RANGE, 11"WC OUTLET PRESS., 1,000,000 BTU/HR

**CAV 998LP-01** FULL SIZE, 1/2" FNPT INLET, 3/4" FNPT OUTLET, 9-13" WC OUTLET ADJ. RANGE, 11"WC OUTLET PRESS., 1,400,000 BTU/HR

*Serving the LP Industry*

*Since 1954*

*Building Relationships*

*is our utmost reward*

1-800-457-3826

# PETROLEUM TANK CORP

## REGULATORS

### SECOND STAGE LOW PRESSURE REGULATOR

CAV 998LP-10 INLINE 3/4" FNPT INLET, 3/4" FNPT OUTLET,  
9-13" WC OUTLET ADJ. RANGE, 11"WC OUTLET  
PRESS., 2,300,000 BTU/HR

CAV 998LP-09 INLINE 1" FNPT INLET, 1" FNPT OUTLET,  
9-13" WC OUTLET ADJ. RANGE, 11"WC OUTLET  
PRESS., 2,300,000 BTU/HR



CAV 998LP-02 FULL SIZE, 3/4" FNPT INLET, 3/4 FNPT OUTLET, 9-13" WC  
OUTLET ADJ . RANGE, 11" WC OUTLET PRESS.,  
1,400,000 BTU/HR

CAV 998LP-03 BACK MOUNT, 1/2" FNPT INLET, 3/4" 90 DEG. FNPT  
OUTLET, 9-13" WC OUTLET ADJ. RANGE, 11"WC  
OUTLET PRESS., 1,000,000 BTU/HR

CAV 998LP-05 ANGLE BODY 3/4" FNPT INLET, 3/4" FNPT LAT OUTLET,  
9-13" WC OUTLET ADJ. RANGE, 11"WC OUTLET PRESS.,  
920,000 BTU/HR

### SECOND STAGE REGULATOR FOR 2 PSIG SYSTEM

These regulators are designed for outdoor use in the correct mounting position with the vent hole turned downwards



CAV 988TP-22 COMPACT, 1/2" FNPT INLET, 1/2" FNPT OUTLET, NON-AD  
JUSTABLE OUTLET PRESS. RANGE, OUTLET PRESS. SET  
TING, 2-4 PSIG, 700,000 BTU/HR

CAV 998TP-08 STANDARD, 1/2" FNPT INLET, 1/2" FNPT OUTLET, 1-2.2  
PSIG OUTLET ADJ. PRESS. , OUTLET PRESS. SETTING  
2PSIG, 1,460,000 BTU/HR



CAV 998TP-07 BACK MOUNT, 3/4" FNPT INLET, 3/4" FNPT 90 DEG. OUT-  
LET, 1-2.2 PSIG OUTLET ADJ. PRESS., OUTLET PRESS. SET  
TING 2 PSIG., 1,500,000 BTU/HR

CAV 998TP-06 3/4" FNPT INLET, 3/4" FNPT OUTLET, OUTLET ADJ.  
RANGE 1-2.2 PSIG, OUTLET PRESS. SETTING 2 PSIG,  
1,680,000 BTU/HR.

*Serving the LP Industry*

*Since 1954*

TABLE OF CONTENTS

1-800-457-3826

*Building Relationships*

*is our utmost reward*



# PETROLEUM TANK CORP

## REGULATORS

### TWIN STAGE REGULATORS

The double stage regulator or so called twin stage is a regulator consisting of two regulation levels, which regulates the inlet pressure, coming from the withdrawal cylinder or tank directly to the inlet pressure of the user appliance.



CAV 988TW-15 COMPACT, 1/4" FNPT INLET, 1/2" FNPT OUTLET, 9-13" WC OUTLET, ADJ. RANGE, 11"WC OUTLET PRESS. SETTING, 750,000 BTU/HR.

CAV 988TW-17 COMPACT, POL INLET, 1/2" FNPT OUTLET, 9-13" WC OUTLET, ADJ. RANGE, 11"WC OUTLET PRESS. SETTING, 750,000 BTU/HR.



CAV 998TW-11 STANDARD, 1/4" FNPT INLET, 3/4" FNPT OUTLET, 9-13" WC , OUTLET, ADJ. RANGE, 11"WC OUTLET PRESS. SETTING, 1,400,000 BTU/HR

CAV 998TW-13 POL INLET, 3/4" FNPT OUTLET, 9-13" WC OUTLET, ADJ. RANGE, 11"WC OUTLET PRESS. SETTING, 1,400,000 BTU/HR.

CAV 998TW-23 STANDARD, 1/4"FNPT INLET, 3/4" FNPT OUTLET, 1-2.2 PSIG OUTLET ADJUSTMENT RANGE, OUTLET PRESS. SETTING 11"WC, 1,460,000 BTU/HR



### AUTOMATIC CHANGEOVER

The double stage automatic changeover regulator is a combination consisting of an automatic changeover working as a first stage coupled to a second stage regulator.

CAV 524AC 1/4" INVERTED FLARE INLET, 1/2" FNPT OUTLET, VENT SIZE 3/4", 160,000 BTU/HR

*Serving the LP Industry*

*Since 1954*

TABLE OF CONTENTS

1-800-457-3826

*Building Relationships*

*is our utmost reward*

# PETROLEUM TANK CORP

## REGULATORS

### COMPACT AUTOMATIC CHANGEOVER

The double stage automatic changeover regulator is a combination consisting of an automatic changeover working as a 1st stage coupled to a 2nd stage regulator. The 1st stage automatic changeover is connected to the 2nd stage regulator automatically changing the gas withdrawal from the exhausted "service" cylinder to the full "reserve" one.



CAV 924NRV POL INLET, 3/8" FNPT OUTLET, VENT, SET POINT 11"WC  
103,000 BTU/HR

### ECONOMY COMPACT TWO STAGE



CAV 524AS 1/4" FNPT INLET, 3/8" FNPT OUTLET, ADJUSTDABLE OUT-  
LET PRESS. -0.5WC TO +1.5WC, 160,000 BTU/HR

### LINE REGULATOR



CAV 90/2 PSI 1/2" FNPT INLET, 1/2" FNPT OUTLET, 376,000 BTU/HR



CAV 95/2 PSI 3/4" FNPT INLET, 3/4" FNPT OUTLET, 756,000 BTU/HR

*Serving the LP Industry*

*Since 1954*

TABLE OF CONTENTS

1-800-457-3826

10

*Building Relationships*

*is our utmost reward*

# PETROLEUM TANK CORP

## FLARE FITTINGS



HLY NS4	3/16" FL
HLY NS4	1/4" FL
HLY NS4	5/16" FL
HLY NS4	3/8" FL
HLY NS4	1/2" FL
HLY NS4	5/8" FL
HLY NS4	3/4" FL

## FORGED FLARE NUTS



HLY NRS4	3/8" FL x 1/4" FL
HLY NRS4	1/2" FL x 3/8" FL
HLY NRS4	5/8" FL x 1/2" FL

## REDUCING FLARE NUTS



HLY US4	1/4" FL
HLY US4	3/8" FL
HLY US4	1/2" FL
HLY US4	5/8" FL

## FORGED SWIVEL NUTS



HLY 48	1/8" FL x 1/8" MNPT
HLY 48	3/16" FL x 1/8" MNPT
HLY 48	1/4" FL x 1/8" MNPT
HLY 48	1/4" FL x 1/4" MNPT
HLY 48	1/4" FL x 3/8" MNPT
HLY 48	5/16" FL x 1/8" MNPT
HLY 48	5/16" FL x 1/4" MNPT
HLY 48	3/8" FL x 1/8" MNPT
HLY 48	3/8" FL x 1/4" MNPT
HLY 48	3/8" FL x 3/8" MNPT
HLY 48	3/8" FL x 1/2" MNPT
HLY 48	3/8" FL x 3/4" MNPT
HLY 48	1/2" FL x 1/4" MNPT
HLY 48	1/2" FL x 3/8" MNPT
HLY 48	1/2" FL x 1/2" MNPT
HLY 48	1/2" FL x 3/4" MNPT
HLY 48	5/8" FL x 1/4" MNPT
HLY 48	5/8" FL x 3/8" MNPT
HLY 48	5/8" FL x 1/2" MNPT
HLY 48	5/8" FL x 3/4" MNPT
HLY 48	3/4" FL x 1/2" MNPT
HLY 48	3/4" FL x 3/4" MNPT

## FLARE X MALE PIPE CONNECTORS

*Serving the LP Industry*

*Since 1954*

TABLE OF CONTENTS

1-800-457-3826

*Building Relationships*

*is our utmost reward*

# PETROLEUM TANK CORP

## FLARE FITTINGS

### FLARE X MALE PIPE ELBOWS



HLY 49	1/8"FL x 1/8" MNPT
HLY 49	3/16"FL x 1/8" MNPT
HLY 49	1/4"FL x 1/8" MNPT
HLY 49	1/4"FL x 1/4" MNPT
HLY 49	5/16"FL x 1/8" MNPT
HLY 49	3/8"FL x 1/8" MNPT
HLY 49	3/8"FL x 1/4" MNPT
HLY 49	3/8"FL x 3/8" MNPT
HLY 49	3/8"FL x 1/2" MNPT
HLY 49	3/8"FL x 3/4" MNPT
HLY 49	1/2"FL x 1/4" MNPT
HLY 49	1/2"FL x 3/8" MNPT
HLY 49	1/2"FL x 1/2" MNPT
HLY 49	1/2"FL x 3/4" MNPT
HLY 49	5/8"FL x 3/8" MNPT
HLY 49	5/8"FL x 1/2" MNPT
HLY 49	5/8"FL x 3/4" MNPT
HLY 49	3/4"FL x 1/2" MNPT

### FLARE X FEMALE PIPE ELBOWS



HLY 50	3/8"FL x 1/4" FNPT
HLY 50	3/8"FL x 3/8" FNPT
HLY 50	3/8"FL x 1/2" FNPT
HLY 50	3/8"FL x 3/4" FNPT
HLY 50	5/16"FL x 1/4" FNPT
HLY 50	1/2"FL x 3/8" FNPT
HLY 50	1/2"FL x 1/2" FNPT.
HLY 50	1/2"FL x 3/4" FNPT
HLY 50	5/8"FL x 3/8" FNPT
HLY 50	5/8"FL x 1/2" FNPT
HLY 50	5/8"FL x 3/4" FNPT

*Serving the LP Industry*

*Since 1954*

**TABLE OF CONTENTS**

**1-800-457-3826**

*Building Relationships*

*is our utmost reward*

# PETROLEUM TANK CORP

## FLARE FITTINGS

### FLARE X FEMALE PIPE CONNECTORS



HLY 46	3/16"FL x 1/8" FNPT
HLY 46	3/16"FL x 1/4" FNPT
HLY 46	1/4"FL x 1/8" FNPT
HLY 46	1/4"FL x 1/4" FNPT
HLY 46	1/4"FL x 3/8" FNPT
HLY 46	3/8"FL x 1/8" FNPT
HLY 46	3/8"FL x 1/4" FNPT
HLY 46	3/8"FL x 3/8" FNPT
HLY 46	3/8"FL x 1/2" FNPT
HLY 46	3/8"FL x 3/4" FNPT
HLY 46	5/16"FL x 1/8" FNPT
HLY 46	5/16"FL x 1/4" FNPT
HLY 46	1/2"FL x 3/8" FNPT
HLY 46	1/2"FL x 1/2" FNPT
HLY 46	1/2"FL x 3/4" FNPT
HLY 46	5/8"FL x 3/8" FNPT
HLY 46	5/8"FL x 1/2" FNPT
HLY 46	5/8"FL x 3/4" FNPT

### FLARE UNIONS



HLY 42	1/8"
HLY 42	3/16"
HLY 42	1/4"
HLY 42	5/16"
HLY 42	3/8"
HLY 42	1/2"
HLY 42	1/2" x 3/8"
HLY 42	5/8"
HLY 42	5/8" x 3/8"
HLY 42	5/8" x 1/2"
HLY 42	3/4"

### FLARE X FLARE MALE ELBOWS



HLY 55	1/4"FL x 1/4"FL
HLY 55	3/8"FL x 3/8"FL
HLY 55	1/2"FL x 3/8"FL
HLY 55	1/2"FL x 1/2"FL
HLY 55	5/8"FL x 1/2"FL
HLY 55	5/8"FL x 5/8"FL

*Serving the LP Industry*

*Since 1954*

TABLE OF CONTENTS

1-800-457-3826

*Building Relationships*

*is our utmost reward*

# PETROLEUM TANK CORP

## FLARE FITTINGS

### FLARE TEE

HLY 44	1/8"FL x 1/8"FL X 1/8"FL
HLY 44	1/4"FL x 1/4"FL X 1/4"FL
HLY 44	3/8"FL x 3/8"FL X 3/8"FL
HLY 44	3/8"FL x 1/2"FL X 3/8"FL
HLY 44	3/8"FL x 3/8"FL X 1/2"FL
HLY 44	1/2"FL x 1/2"FL X 1/2"FL
HLY 44	1/2"FL x 1/2"FL X 3/8"FL
HLY 44	1/2"FL x 3/8"FL X 1/2"FL
HLY 44	1/2"FL x 3/8"FL X 3/8"FL
HLY 44	5/8"FL x 5/8"FL X 5/8"FL
HLY 44	5/8"FL x 5/8"FL X 1/2"FL
HLY 44	5/8"FL x 5/8"FL X 3/8"FL



### FLARE X MALE PIPE TEE

HLY 45	3/8"FL x 3/8"FL x 3/8" MNPT
HLY 45	1/2"FL x 1/2"FL x 3/8" MNPT
HLY 45	1/2"FL x 1/2"FL x 1/2" MNPT
HLY 45	5/8"FL x 5/8"FL x 1/2" MNPT



### FLARE CROSS

HLY 455	1/4"
HLY 455	3/8"
HLY 455	1/2"
HLY 455	5/8"



### FLARE CAPS

HLY 56	3/16"
HLY 56	1/4"
HLY 56	5/16"
HLY 56	3/8"
HLY 56	1/2"
HLY 56	5/8"



### FLARE PLUGS

HLY 57	3/16" FL
HLY 57	1/4"FL
HLY 57	5/16" FL
HLY 57	3/8" FL
HLY 57	1/2" FL
HLY 57	5/8" FL



*Serving the LP Industry*

*Since 1954*

TABLE OF CONTENTS

1-800-457-3826

14

*Building Relationships*

*is our utmost reward*

# PETROLEUM TANK CORP

## POL ADAPTORS



HLY 1500  
HLY 1501  
HLY 1504

7/8" POL NUT  
1 1/8" POL NUT  
POL TAIL PIECE



HLY 1507

POL PLUG



M/E M970P

POL PLUG, PLASTIC



HLY 1508

POL CAP



HLY 1510 3/8"  
HLY 1510 1/2"  
HLY 1510 5/8"

Male POL x 3/8" MNPT, SINGLE PC. ADAPTOR  
Male POL x 1/2" MNPT, SINGLE PC. ADAPTOR  
Male POL x 5/8" MALE FL, SINGLE PC. ADAPTOR



HLY 1511B

POL TEE BLOCK W/O CHECK



HLY 1512

1/4 FNPT x 1/4 MNPT, TEE CHECK



M/E ME284  
M/E ME285  
M/E ME286  
M/E ME287

Female POL x 1/4" MNPT, Single Piece Adaptor  
Female POL x 3/8" MNPT, Single Piece Adaptor  
Female POL x 1/2" MNPT, Single Piece Adaptor  
Female POL x 3/4" MNPT, Single Piece Adaptor



## SOFT NOSE POL WITH PLASTIC HANDWHEEL

M/E ME1645  
M/E ME1653  
M/E ME1654

Excess Flow POL x 9/16"-18LH  
Excess Flow POL x 1/4" MNPT  
Full Flow POL x 1/4" MNPT

## PIGTAILS



M/E K845  
M/E K160  
M/E K162  
M/E K166

**1/4" O. D. TUBING**  
POL x POL, 7/8" Hex, 12" LG.  
POL x POL, 7/8" Hex 20" LG.  
POL x POL, 7/8" Hex, 36" LG.  
POL x POL, 7/8" Hex, 48" LG.



M/E K240  
M/E K249

POL x 1/4" Inverted Flare, 7/8" Hex, 12" lg  
POL x 1/4" Inverted Flare, 7/8" Hex, 36" lg.



M/E K807  
M/E K806  
M/E K805

POL x 1/4" MNPT, 7/8" Hex, 6" lg.  
POL x 1/4" MNPT, 7/8" Hex, 12" lg.  
POL x 1/4" MNPT, 7/8" Hex, 18" lg.

*Serving the LP Industry*

*Since 1954*

*Building Relationships*

*is our utmost reward*

1-800-457-3826

# PETROLEUM TANK CORP

## HOGTAILS



M/E K865  
M/E K862

### 3/8" O. D. TUBING

POL x POL, 7/8" Hex, 6" lg.  
POL x POL, 7/8" Hex, 12" lg.



M/E K520  
M/E K460

POL x 1/2" MNPT, 7/8" Hex, 12" lg.  
POL x 1/4" MNPT, 7/8" Hex, 12" lg

## PIGTAILS



M/B TPT  
M/B THT-4  
M/EB TPT-4V

PIGTAIL, POL X POL  
PIGTAIL, POL X 1/4" MNPT  
PIGTAIL, POL X 1/4" INVERTED FLARE

M/B THT  
M/B TPT-4  
M/B TPT-4V

HOGTAIL, POL X POL  
HOGTAIL, POL X 1/4" MNPT  
HOGTAIL, POL X 1/4" INVERTED FLARE

### .THERMOPLASTIC PIGTAILS & HOGTAILS EACH PIGTAIL & HOGTAIL IN 12", 20", 30", OR 36" LENGTHS

## HOSE ASSEMBLIES



M/B 40411

### 1/4" I. D. HIGH PRESSURE ASSEMBLY

1/4"MNPT x Type 1 ACME  
(15", 20" Lengths)



M/B 40402

1/4" Inverted Flare x Soft Nose Handwheel Excess Flow POL  
(20", 24" Lengths)



M/B 40403

1/4" Inverted flare x POL  
(15", 20", 24", 30", 48", Lengths)



M/B 42410

3/8" MNPT x 3/8" FE. FL.  
(24", 36", 48" Lengths)



M/B 42413

3/8" FE. FL. x 3/8" FE. FL.  
(24", 36", 48", 60", 72", 144" Lengths)

*Serving the LP Industry*

*Since 1954*

**TABLE OF CONTENTS**

**1-800-457-3826**

*Building Relationships*

*is our utmost reward*



# PETROLEUM TANK CORP

## HOSE ASSEMBLIES



M/B 40407

Soft Nose Handwheel POL x 1"-20 Male Swivel  
(48", 60", 144" Lengths)



M/B 42421

1"-20 Female Swivel x 1"-20 Male Swivel  
(60", 144" Lengths)



M/E MER428

F. QCC X M. QCC/F POL HOSE  
(60", 120" Lengths)

## HOSE BOXES



M/E ME951 BLK  
M/E ME951 IVY

### GAS DISTRIBUTION BOX

1 5/16" M Acme/F POL Single outlet w/1/2" FNPT Inlet  
1 5/16" M Acme/F POL Single outlet w/1/2" FNPT Inlet



M/E ME952 BLK  
M/E ME952 IVY

1 5/16" M Acme/F POL Dual outlet w/1/2" FNPT Inlet  
1 5/16" M Acme/F POL Dual outlet w/1/2" FNPT Inlet

## QCC ADAPTORS



M/E ME517  
M/E ME518  
M/E ME519

### QCC ADAPTORS

BLACK, 1 5/16" ACME X 1/4" MNPT (100,000 BTU'S)  
GREEN, 1 5/16" ACME X 1/4" MNPT (200,000 BTU'S)  
RED, 1 5/16" ACME X 1/4" MNPT (400,000 BTU'S)

*Serving the LP Industry*

*Building Relationships*

*Since 1954*

*1-800-457-3826*

*is our utmost reward*

# PETROLEUM TANK CORP

## SERVICE VALVES

### DOT FORK LIFT & ASME MOTOR FUEL



M/E 9101H5 3/4" MNGT x 3/8" Flare(90), Motor Fuel, 3.3 gpm excess flow



M/ E 9101P5H 3/4" MNGT x 3/8"-18, DOT Forklift, 2.6 gpm excess flow

### MULTI SERVICE FOR ASME TANKS



CAV 7556 3/4" MNPT x POL(Vapor) x 1 1/4" ACME(Filler)



CAV G8475 2 1/2" MNPT x POL(Vapor) x 1 3/4" ACME(Filler)

### DOT CYLINDER SERVICE VALVE



CAV 80-5016 3/4" NGT x Female POL, 10.6" Dip tube, ( up to 100# Cyl.)

CAV 80-6032 3/4" NGT x Female POL, 10.6" Dip tube, (up to 200# Cyl.)

CAV 8555 3/4" MNPT x Female POL, 11.6 Dip Tube (up to 200# Cyl.)

### CYLINDER FILL WITH OPD (OVERFILL PREVENTION)



CAV 307-04 4# Cyl, 3/4"-14 NGT x Type 1 ACME & POL, 3.2" dip tube

CAV 307-20 20# Cyl, 3/4"-14 NGT x Type 1 ACME & POL, 4" dip tube

CAV 307-30 30# Cyl, 3/4"-14 NGT x Type 1 ACME & POL, 4.8" dip tube

CAV 307-40 40# Cyl, 3/4"-14 NGT x Type 1 ACME & POL, 6.5" dip tube

### CHECK FILLER VALVES



M/E ME601-10 1 1/4" MNPT x 1 3/4" Male ACME



M/E ME601-6 3/4" MNPT x 1 3/4" Male ACME

### FORK LIFT CYLINDER CONNECTORS



M/W M220F 1 1/4" ACME x 1/4" FNPT, (Fuel Line)



M/E M220M 3/8" FNPT x 1 1/4" ACME, (Service Valve)

*Serving the LP Industry*

*Since 1954*

TABLE OF CONTENTS

1-800-457-3826

*Building Relationships*

*is our utmost reward*

# PETROLEUM TANK CORP

## SERVICE VALVES



M/E MEJ400

Brass Liquid Level Vent Valve



M/E MEJ401

Brass Screw with Seat



M/E TSS3169

Liquid Vent Valve with T-Handle - (Stainless Steel)

## LIQUID WITHDRAWAL VALVES & ADAPTORS



M/E 7590U

3/4" Valve for Stationary tanks

M/E 7591U

1 1/4" Valve for Stationary tanks

M/E 7590U-10

Adaptor to be used with CAV 7591U Valve



M/E ME449

3/4" FNPT X 3/4" MNPT W/1/4" MNPT



M/E ME453

3/4" MNPT x 3/4" FNPT Outlet Adaptor

M/E ME455

3/4" MNPT x 3/4" MNPT Outlet Adaptor

M/E ME458

1 5/8" NF X 3/4" FNPT

## RELIEF VALVES



M/E MEH225

1/4" MNPT (Discharge PSI 440)



M/E MEV75

3/4" NPT, (Discharge PSI 375)



CAV 66-1027

3/4" NPT, 45 degree Adaptor, (Discharge PSI 375)



CAV H225-250

3/4" NPT, 250 PSI Discharge Setting

CAV H250-250

1" NPT, 250 PSI Discharge Setting

CAV H275-250

1 1/4" NPT, 250 PSI Discharge Setting



M/E MEV200-250

2" MNPT, Flush Mount, 250 PSI Discharge Setting

M/E MEV300-250

3" MNPT, Flush Mount, 250 PSI Discharge Setting

## HYDROSTATIC RELIEF VALVES

## DOT FORK LIFT CYLINDERS

## ASME & DOT CONTAINERS

*Serving the LP Industry*

*Building Relationships*

*Since 1954*

*1-800-457-3826*

*is our utmost reward*

# PETROLEUM TANK CORP

## BACK CHECK VALVES



M/E ME870-6  
M/E ME870-10  
M/E ME870-16  
M/E ME870S-24  
M/E ME870S-16

### METAL TO METAL SEAT

3/4" MNPT x 3/4" FNPT, Brass, (21 gpm Flow)  
1 1/4" MNPT x 1 1/4" FNPT, Brass, (55 gpm Flow)  
2" MNPT x 2" FNPT, Brass, (150 gpm Flow)  
3" MNPT x 3" FNPT, Steel, (250 gpm Flow)  
2" MNPT x 2" FNPT, Steel, (150 gpm Flow)

## EXCESS FLOW VALVES



M/E ME880-6  
M/E ME880S-6

### MALE NPT X FEMALE NPT

3/4" MNPT x 3/4" FNPT, Brass  
3/4" MNPT x 3/4" FNPT Steel  
(4.6, 14, 17, 22, 28 Closing Flow gpm)

M/E ME 880-10  
M/E ME880S-10

1 1/4" MNPT x 1 1/4" FNPT, Brass  
1 1/4" MNPT x 1 1/4" FNPT, Steel  
(32, 42 Closing Flow gpm)

M/E ME880-16  
M/E ME880S-16

2" MNPT x 2" FNPT, Brass  
2" MNPT x 2" FNPT, Steel  
(80, 105, 114 Closing Flow gpm)

## ACME ADAPTORS



M/E ME498-4/2  
M/E ME498-6/3  
M/E ME520-8  
M/E ME215  
M/E ME216  
M/E ME217  
M/E ME233  
M/E ME502-12/8  
M/E ME502-16-10  
M/E ME503-16  
M/E ME263  
M/E ME262

### MALE ACME X MALE NPT ADAPTORS

1 1/4" x 1/2", Brass  
1 1/4" x 3/4", Brass  
1 1/4" x 1", Steel  
1 3/4" x 3/4", Brass  
1 3/4" x 1", Brass  
1 3/4" x 1 1/4", Brass  
2 1/4" x 1 1/4", Brass  
2 1/4" x 1 1/2", Brass  
2 1/4" x 2", Brass  
3 1/4" x 2", Brass  
3 1/4" x 2", Steel  
3 1/4" x 3", Brass



### FLO MAX DRY BREAK TRANSFER SYSTEM

M/E ME806-16

LOW EMISSION TRANSFER VALVE  
2" FNPT X 3 1/4" F. ACME SWIVEL CONNECTION



M/E ME868-16

LOW EMISSION ACME ADAPTOR  
2" MNPT X 3 1/4" MALE ACME

*Serving the LP Industry*

*Since 1954*

*1-800-457-3826*

*Building Relationships*

*is our utmost reward*

# PETROLEUM TANK CORP

## ACME ADAPTORS

### ACME ADAPTOR CAPS



M/E ME611	2 1/4" F. ACME x 1 3/4" M. ACME, Brass
M/E ME612	3 1/4" F. ACME x 1 3/4" M. ACME, Brass
M/E ME622	3 1/4" F. ACME x 1 3/4" M. ACME, Steel

### ACME FILL CHECK ADAPTORS



M/E ME570	1 3/4" F. ACME x 1 3/4" M. ACME
-----------	---------------------------------



M/E ME572	1 3/4" F. ACME x 1 3/4" M. ACME
-----------	---------------------------------



M/E ME571	1 3/4" F. ACME x 1 3/4" F. ACME, Brass
-----------	--



M/E ME574	1 3/4" F. ACME x 1 3/4" F. ACME with Vent Valve
-----------	---

### MALE ACME X MALE ACME ADAPTORS



M/E ME270	1 1/4" x 1 1/4", Brass
M/E ME273	1 3/4" x 1 3/4", Brass
M/E ME536-14	1 3/4" x 1 3/4", Steel
M/E ME536-18	2 1/4" x 2 1/4", Steel
M/E ME536-26	3 1/4" x 3 1/3", Steel

### MALE ACME X FEMALE NPT ADAPTORS



M/E ME498-4/2	1 1/4" x 1/4", Brass
M/E ME498-6/3	1 1/4" x 3/8", Brass
M/E ME192	1 1/4" x 1/2", Brass
M/E ME193	1 1/4" x 3/4", Brass
M/E ME210	1 3/4" x 1/4", Brass
M/E ME211	1 3/4" x 3/8", Brass
M/E ME212	1 3/4" x 1/2", Brass
M/E ME213	1 3/4" x 3/4", Brass
M/E ME214	1 3/4" x 1", Brass
M/E ME502-12/8	2 1/4" x 1", Brass
M/E ME502-16/10	2 1/4" x 1 1/4", Brass
M/E ME502-16/12	2 1/4" x 1 1/2", Brass
M/E ME250	3 1/4" x 1 1/4", Brass
M/E ME252	3 1/4" x 2", Brass
M/E ME508-24	3 1/4" x 3", Brass

*Serving the LP Industry*

*Building Relationships*

*Since 1954*

*1-800-457-3826*

*is our utmost reward*

# PETROLEUM TANK CORP

## FILLER COUPLINGS

### FEMALE ACME FILLER COUPLINGS



M/E ME100 1 1/4" x 3/8" MNPT, Brass  
M/E ME101 1 1/4" x 1/2" MNPT, Brass



M/E ME110 1 3/4" x 1/2" MNPT, Brass  
M/E ME111 1 3/4" x 3/4" MNPT, Brass  
M/E ME111S 1 3/4" x 3/4" MNPT, Steel  
M/E ME112 1 3/4" x 1" MNPT, Brass



M/E ME120 2 1/4" x 1 1/4" MNPT, Brass  
M/E ME121S 2 1/4" x 1 1/4" MNPT, Steel



M/E ME442 3 1/4" x 1 1/4" MNPT, Brass



M/E ME130 3 1/4" x 2" MNPT, Brass  
M/E ME130S 3 1/4" x 2" MNPT, Steel



M/E M635-8 1 3/4" X 1" MNPT, 7" LG, Steel



M/E ME392 1 5/16" ACME x 1/4" FNPT, Female Swivel



M/E ME568 1 3/4" F. ACME x Female POL

### FEMALE ACME VAPOR RETURN COUPLINGS



M/E ME140 1 1/4" x 3/8" MNPT, Brass  
M/E ME141 1 1/4" x 1/2" MNPT, Brass  
M/E ME150 1 3/4" x 3/4" MNPT, Brass



M/E ME646 1 3/4" x 3/4" MNPT, 7" long, Steel



M/E ME151 1 3/4" x 1" MNPT, Brass  
M/E ME151S 1 3/4" x 1" MNPT, Steel

### POL FILLER COUPLING



M/E ME390 Soft Nose Male POL x 1/4" MNPT, 6" long, Brass  
M/E ME516 1 5/16" ACME x 1/4" MNPT

### LIFT TRUCK FILLER COUPLING



M/E ME790 1 1/4" F. ACME x 1/4" MNPT

*Serving the LP Industry*

*Since 1954*

TABLE OF CONTENTS

1-800-457-3826

*Building Relationships*

*is our utmost reward*

# PETROLEUM TANK CORP

## HOSE END FILL VALVE



M/E ME800

### HOSE END VALVE

1 3/4" ACME x 1" FNPT, 90 degree



M/E ME820-4  
M/E ME820-6  
M/E ME820-8

1/2" MNPT x 1/2" MNPT  
3/4" MNPT x 3/4" MNPT  
1" MNPT x 1" MNPT, (use with M635-8)



M/E ME800EXT

1 3/4" ACME x 1" MNPT, 6" Extension

### EXTENDED FILLER ADAPTORS



M/E ME572EXT  
M/E ME572EXTHD

1 3/4" ACME x 1 3/4" ACME, Brass  
1 3/4" ACME x 1 3/4" ACME, Heavy Duty



M/E ME574EXT  
M/E ME574EXTHD

1 3/4" ACME x 1 3/4" ACME, Built in Vent Valve  
1 3/4" ACME x 1 3/4" ACME Heavy Duty, Built in vent valve



M/E MEP860S

### PULLAWAY VALVE

3/4" INLET X 3/4" OUTLET, Hose End Valve

## ACCESSORIES



M/E MEP148

Fits 1 1/4" & 1 3/4" Cap sizes



PET P167

Fits 2 1/4" & 3 1/4" Cap sizes



PET AVH1

### NOZZLE HOLSTER

Nozzle Holster for 90 degree, ME800 Nozzle



M/E MEJ01

### HOSE END SWIVEL

1" MNPT x 1" FNPT



M/B 100-206

### REGULATOR BRACKET

Regulator Mounting Bracket

*Serving the LP Industry*

*Since 1954*

## RING & CHAIN ASSEMBLIES

*Building Relationships*

*is our utmost reward*

1-800-457-3826



# PETROLEUM TANK CORP

## ACCESSORIES

### DUST PLUGS & RELIEF VALVE CAPS



M/E ME179	1 1/4" Plug, Plastic
M/E ME180	2 1/4" Plug, Plastic
M/E ME181	3 1/4" Plug, Plastic
M/E MEH501-.437	Cap for MEH225
M/E MEP175C	Cap for CAV 66-1057

### FEMALE ACME CAPS



M/E ME108	1 1/4", Plastic
M/E ME109	1 3/4", Plastic



M/E ME229	1 3/4", Brass
M/E ME219	1 3/4", Steel
M/E ME431	2 1/4", Brass
M/E ME432	2 1/4", Steel



M/E ME441	3 1/4", Brass
M/E ME443	2 1/4", Steel



M/E ME441F	3 1/4" Cap with Brake Lock ring
------------	---------------------------------

### SPANNER WRENCH



M/E MEP120	18" long, Aluminum
------------	--------------------

### WASHERS, GASKETS & O-RINGS



M/E MEW4	1 1/4" ACME WASHER, Fork Lift Conn.
M/E MEW2	1 3/4" ACME WASHER, Filler & Vapor Valves & Adapt.
M/E MEW4	1 1/4" ACME WASHER, Filler & Vapor Valves & Adapt.
M/E MEW5	2 1/4" ACME WASHER, Filler & Vapor Valves & Adapt.
M/E MEW6	3 1/4" ACME WASHER, Filler & Vapor Valves & Adapt.



M/E ME568-110-01	POL O- RING, POL Nipple
M/E ME220M02	1 1/4" ACME O-RING, Internal Fork Lift
M/E A3184-20R	2 1/4" ACME O-RING, Filler & Vapor Valves & Adaptors
M/E A3194-20R	3 1/4" ACME O-RING, Filler & Vapor Valves & Adaptors

### QUICK ACTING TOGGLE VALVES



M/E ME791C	1/2" FNPT x 1/4" FNPT
M/E ME791D	1/2" FNPT x 1/2" FNPT
M/E ME792C	1/2" FNPT x 1/4" FNPT, with Locking Handle
M/E ME792D	1/2" FNPT x 1/2" FNPT, with Locking Handle

*Serving the LP Industry*

*Since 1954*

**TABLE OF CONTENTS**

**1-800-457-3826**

*Building Relationships*

*is our utmost reward*



# PETROLEUM TANK CORP

## BRASS PIPE FITTINGS



HLY 100 1/8" PIPE ELBOW  
HLY 100 1/4" PIPE ELBOW  
HLY 100 3/8" PIPE ELBOW  
HLY 100 1/2" PIPE ELBOW  
HLY 100 3/4" PIPE ELBOW

## BRASS PIPE ELBOWS



HLY 101 1/8" PIPE TEE  
HLY 101 1/4" PIPE TEE  
HLY 101 3/8" PIPE TEE  
HLY 101 1/2" PIPE TEE  
HLY 101 3/4" PIPE TEE

## BRASS PIPE TEE



HLY 102 1/8" 90 D.PIPE ST ELL  
HLY 102 1/4" 90 D.PIPE ST ELL  
HLY 102 3/8" 90 D.PIPE ST ELL  
HLY 102 1/2" 90 D.PIPE ST ELL  
HLY 102 3/4" 90 D.PIPE ST ELL

## BRASS STREET ELBOWS



HLY 103 1/8" PIPE COUPLING  
HLY 103 1/4" PIPE COUPLING  
HLY 103 1/4" x 1/8" PIPE COUPLING  
HLY 103 3/8" PIPE COUPLING  
HLY 103 3/8" x 1/4" PIPE COUPLING  
HLY 103 1/2" PIPE COUPLING  
HLY 103 1/2" x 1/4" PIPE COUPLING  
HLY 103 1/2" x 3/8" PIPE COUPLING  
HLY 103 3/4" PIPE COUPLING  
HLY 103 3/4" x 1/2" PIPE COUPLING

## BRASS PIPE COUPLING



HLY 104 1/2" PIPE UNION  
HLY 104 3/4" PIPE UNION

## BRASS PIPE UNION



HLY 105 1/4" INVERTED FLARE NUT

## BRASS INVERTED FLARE NUT

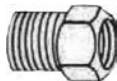

HLY 110 1/4" x 1/8" PIPE BUSHING  
HLY 110 3/8" x 1/8" PIPE BUSHING  
HLY 110 3/8" x 1/4" PIPE BUSHING  
HLY 110 1/2" x 1/8" PIPE BUSHING  
HLY 110 1/2" x 1/4" PIPE BUSHING  
HLY 110 1/2" x 3/8" PIPE BUSHING

## BRASS PIPE BUSHINGS

*Serving the LP Industry*

*Building Relationships*

*Since 1954*

*1-800-457-3826*

*is our utmost reward*

# PETROLEUM TANK CORP

## BRASS PIPE FITTINGS



HLY 110 3/4" x 1/8"	PIPE BUSHING
HLY 110 3/4" x 1/4"	PIPE BUSHING
HLY 110 3/4" x 3/8"	PIPE BUSHING
HLY 110 3/4" x 1/2"	PIPE BUSHING
HLY 110 1" x 3/4"	PIPE BUSHING
HLY 110 1 1/4" x 3/4"	PIPE BUSHING
HLY 110 1 1/4" x 1"	PIPE BUSHING
HLY 110FB 1/2" x 3/8"	PIPE FACE BUSHING

## BRASS PIPE BUSHINGS

## BRASS PIPE CLOSE NIPPLE



HLY 112 1/8"	CLOSE NIPPLE
HLY 112 1/4"	CLOSE NIPPLE
HLY 112 3/8"	CLOSE NIPPLE
HLY 112 1/2"	CLOSE NIPPLE
HLY 112 3/4"	CLOSE NIPPLE

## BRASS PIPE NIPPLES



HLY 113 1/8" x 1 1/2"	1 1/2" LONG NIPPLE
HLY 113 1/8" x 2"	2" LONG NIPPLE
HLY 113 1/8" x 3"	3" LONG NIPPLE
HLY 113 1/8" x 4"	4" LONG NIPPLE
HLY 113 1/8" x 4 1/2"	4 1/2" LONG NIPPLE
HLY 113 1/8" x 5"	5" LONG NIPPLE
HLY 113 1/4" x 1 1/2"	1 1/2" LONG NIPPLE
HLY 113 1/4" x 2"	2" LONG NIPPLE
HLY 112 1/4" x 2 1/2"	2 1/2" LONG NIPPLE
HLY 113 1/4" x 3"	3" LONG NIPPLE
HLY 113 1/4" x 4"	4" LONG NIPPLE
HLY 113 1/4" x 5"	5" LONG NIPPLE
HLY 113 1/4" x 6"	6" LONG NIPPLE
HLY 113 3/8" x 1 1/2"	1 1/2" LONG NIPPLE
HLY 113 3/8" x 2"	2" LONG NIPPLE
HLY 113 3/8" x 3"	3" LONG NIPPLE
HLY 113 1/2" x 2"	2" LONG NIPPLE
HLY 113 1/2" x 3"	3" LONG NIPPLE
HLY 113 1/2" x 4"	4" LONG NIPPLE
HLY 113 3/4" x 2"	2" LONG NIPPLE
HLY 113 3/4" x 3"	3" LONG NIPPLE
HLY 113 3/4" x 4"	4" LONG NIPPLE
HLY 113 3/4" x 5"	5" LONG NIPPLE

*Serving the LP Industry*

*Since 1954*

TABLE OF CONTENTS

1-800-457-3826

*Building Relationships*

*is our utmost reward*

# PETROLEUM TANK CORP

## BRASS PIPE FITTINGS



<u>BRASS HEX NIPPLES</u>	
HLY 116 1/8"	HEX NIPPLE
HLY 116 1/4"	HEX NIPPLE
HLY 116 1/4" x 1/8"	HEX NIPPLE
HLY 116 3/8"	HEX NIPPLE
HLY 116 3/8" x 1/8"	HEX NIPPLE
HLY 116 3/8" x 1/4"	HEX NIPPLE
HLY 116 1/2" x 3/8"	HEX NIPPLE
HLY 116 3/4"	HEX NIPPLE
HLY 116 3/4" x 1/2"	HEX NIPPLE
HLY 116 1/2"	HEX NIPPLE

## BRASS REDUCING OR INCREASING ADAPTORS

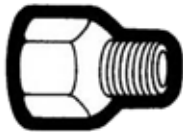

HLY 120R 1/4" x 1/8"	FNPT X MNPT ADAPTOR
HLY 120R 3/8" x 1/4"	FNPT X MNPT ADAPTOR
HLY 120R 1/2" x 3/8"	FNPT X MNPT ADAPTOR
HLY 120R 1/2" x 1/2"	FNPT X MNPT ADAPTOR
HLY 120R 1/2" x 3/4"	MNPT X FNPT ADAPTOR
HLY 120R 3/4" x 1/2"	FNPT X MNPT ADAPTOR

## BRASS PIPE PLUGS



HLY 121 1/8"	PIPE PLUG
HLY 121 1/4"	PIPE PLUG
HLY 121 3/8"	PIPE PLUG
HLY 121 1/2"	PIPE PLUG
HLY 121 3/4"	PIPE PLUG

## BRASS PIPE CROSS

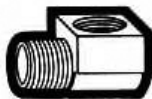

HLY 123 1/8"	PIPE CROSS
HLY 123 1/4"	PIPE CROSS
HLY 123 3/8"	PIPE CROSS

*Serving the LP Industry*

*Since 1954*

TABLE OF CONTENTS

1-800-457-3826

27

*Building Relationships*

*is our utmost reward*

# PETROLEUM TANK CORP

## BRASS PIPE FITTINGS



HLY 138 3/8"

## BRASS HOSE BARB SPLICE

HOSE BARB SPLICE

## BRASS HOSE BARB FITTINGS

HLY 139 1/8" x 1/8"

HOSE BARB X MNPT

HLY 139 3/16" x 1/8"

HOSE BARB X MNPT

HLY 139 3/16" x 1/4"

HOSE BARB X MNPT

HLY 139 1/4" x 1/8"

HOSE BARB X MNPT

HLY 139 1/4" x 1/4"

HOSE BARB X MNPT

HLY 139 1/4" x 3/8"

HOSE BARB X MNPT



HLY 139 3/8" x 1/4"

HOSE BARB X MNPT

HLY 139 3/8" x 3/8"

HOSE BARB X MNPT

HLY 139 3/8" x 1/2"

HOSE BARB X MNPT

HLY 139 5/16" x 1/8"

HOSE BARB X MNPT

HLY 139 5/16" x 1/4"

HOSE BARB X MNPT

HLY 139 1/2" x 3/8"

HOSE BARB X MNPT

HLY 139 1/2" x 1/2"

HOSE BARB X MNPT

HLY 139 5/8" x 3/8"

HOSE BARB X MNPT

HLY 139 5/8" x 1/2"

HOSE BARB X MNPT

HLY 139 5/8" x 3/4"

HOSE BARB X MNPT

HLY 144 1/4" x 1/4"

HOSE BARB X FNPT

HLY 142 3/8" x 3/8"

HOSE BARB X FNPT

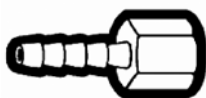

HLY 145 1/4" x 3/8"

SWIVEL FLARE X HOSE BARB

HLY 145 3/8" x 3/8"

SWIVEL FLARE X HOSE BARB

HLY 145 3/8" x 1/2"

HOSE BARB X SWIVEL FLARE

## BRASS NEEDLE VALVES



HLY 142 1/4"

COMPRESSION NEEDLE VALVE

HLY 142 3/8"

COMPRESSION NEEDLE VALVE



HLY 226 1/8"

MNPT X FNPT NEEDLE VALVE

HLY 226 1/4"

MNPT X FNPT NEEDLE VALVE



HLY 227 1/8"

FNPT X FNPT NEEDLE VALVE

HLY 227 1/4"

FNPT X FNPT NEEDLE VALVE



HLY 228 1/8"

MNPT X MNPT NEEDLE VALVE

HLY 228 1/4"

MNPT X MNPT NEEDLE VALVE

*Serving the LP Industry*

*Since 1954*

*1-800-457-3826*

*Building Relationships*

*is our utmost reward*

# PETROLEUM TANK CORP

## BLACK PIPE FITTINGS

### 90 DEGREE ELBOWS



U-B 0002	1/8" BLK. ELL
U-B 0004	1/4" BLK. ELL
U-B 0006	3/8" BLK. ELL
U-B 0008	1/2" BLK. ELL
U-B 0010	3/4" BLK. ELL
U-B 0012	1" BLK. ELL
U-B 0014	1 1/4" BLK. ELL
U-B 0016	1 1/2" BLK. ELL
U-B 0018	2" BLK. ELL

### 90 DEGREE REDUCING ELBOWS



U-B 0032	1/2" x 3/8" BLK. REDUCING ELL
U-B 0038	3/4" x 1/2" BLK. REDUCING ELL
U-B 0042	1" x 1/2" BLK. REDUCING ELL
U-B 0044	1" x 3/4" BLK. REDUCING ELL
U-B 0046	1 1/4" x 1/2" BLK. REDUCING ELL
U-B 0048	1 1/4" x 3/4" BLK. REDUCING ELL
U-B 0050	1 1/4" x 1" BLK. REDUCING ELL

### 45 DEGREE ELBOWS



U-B 0088	1/2" BLK. ELL
U-B 0090	3/4" BLK. ELL

### 90 DEGREE STREET ELBOWS



U-B 0112	1" BLK. STREET ELBOW
U-B 0114	1/4" BLK. STREET ELBOW
U-B 0116	3/8" BLK. STREET ELBOW
U-B 0118	1/2" BLK. STREET ELBOW
U-B 0120	3/4" BLK. STREET ELBOW
U-B 0122	1" BLK. STREET ELBOW
U-B 0124	1 1/4" BLK. STREET ELBOW
U-B 0126	1 1/2" BLK. STREET ELBOW
U-B 0128	2" BLK. STREET ELBOW

### 45 DEGREE STREET ELBOWS



U-B 0162	1", 45 DEGREE, BLK. STREET ELBOW
----------	----------------------------------

### BLACK PIPE "TEES"



U-B 0206	1/8" BLK. TEE
U-B 0208	1/4" BLK. TEE
U-B 0210	3/8" BLK. TEE
U-B 0212	1/2" BLK. TEE

*Serving the LP Industry*

*Since 1954*

TABLE OF CONTENTS

1-800-457-3826

29

*Building Relationships*

*is our utmost reward*

# PETROLEUM TANK CORP

## BLACK PIPE FITTINGS



U-B 0214	3/4" BLK TEE.
U-B 0216	1" BLK TEE
U-B 0218	1 1/4" BLK TEE.
U-B 0220	1 1/2" BLK TEE.
U-B 0222	2" BLK TEE.

## BLACK PIPE TEES

## BLACK REDUCING COUPLINGS



U-B 0536	3/8" x 1/4" BLK REDUCING COUPLING
U-B 0542	1/2" x 3/8" BLK REDUCING COUPLING
U-B 0548	3/4" x 1/2" BLK REDUCING COUPLING
U-B 0552	1" x 1/2" BLK REDUCING COUPLING
U-B 0554	1" x 3/4" BLK REDUCING COUPLING
U-B 0560	1 1/4" x 3/4" BLK REDUCING COUPLING
U-B 0574	2" x 3/4" BLK REDUCING COUPLING

## BLACK PIPE CAPS



U-B 0646	1/4" BLK CAP
U-B 0648	3/8" BLK CAP
U-B 0650	1/2" BLK CAP
U-B 0652	3/4" BLK CAP
U-B 0654	1" BLK CAP
U-B 0656	1 1/4" BLK CAP
U-B 0658	1 1/2" BLK CAP
U-B 0660	2" BLK CAP

## BLACK PIPE CROSSES



U-B 0746	1/2" BLK CROSS
U-B 0748	3/4" BLK CROSS

## BLACK REDUCING BUSHINGS



U-B 0810	1/4" x 1/8" BLK BUSHING
U-B 0812	3/8" x 1/8" BLK BUSHING
U-B 0814	3/8" x 1/4" BLK BUSHING
U-B 0816	1/2" x 1/8" BLK BUSHING
U-B 0818	1/2" x 1/4" BLK BUSHING
U-B 0820	1/2" x 3/8" BLK BUSHING
U-B 0822	3/4" x 1/4" BLK BUSHING
U-B 0824	3/4" x 3/8" BLK BUSHING
U-B 0826	3/4" x 1/2" BLK BUSHING

*Serving the LP Industry*

*Since 1954*

TABLE OF CONTENTS

1-800-457-3826

*Building Relationships*

*is our utmost reward*

# PETROLEUM TANK CORP

## BLACK PIPE FITTINGS



U-B 0828 1" x 3/8" BLK BUSHING  
U-B 0830 1" x 1/2" BLK BUSHING  
U-B 0832 1" x 3/4" BLK BUSHING

U-B 0834 1 1/4" x 1/2" BLK BUSHING  
U-B 0836 1 1/4" x 3/4" BLK BUSHING  
U-B 0844 1 1/2" x 1" BLK BUSHING  
U-B 0846 1 1/2" x 1 1/4" BLK BUSHING  
U-B 0850 2" x 1" BLK BUSHING  
U-B 0852 2" x 1 1/4" BLK BUSHING  
U-B 0854 2" x 1 1/2" BLK BUSHING

## BLACK REDUCING BUSHINGS

## BLACK PLUG



U-B 1110 3/8" BLK PLUG  
U-B 1112 1/2" BLK PLUG  
  
U-B 1114 3/4" BLK PLUG  
U-B 1116 1" BLK PLUG  
U-B 1118 1 1/4" BLK PLUG  
U-B 1120 1 1/2" BLK PLUG  
U-B 1122 2" BLK PLUG

## BLACK PIPE UNIONS

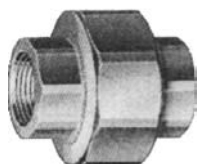

U-B 1306 1/8" BLK UNION  
U-B 1308 1/4" BLK UNION  
U-B 1310 3/8" BLK UNION  
U-B 1312 1/2" BLK UNION  
U-B 1314 3/4" BLK UNION  
U-B 1316 1" BLK UNION  
U-B 1318 1 1/4" BLK UNION  
U-B 1320 1 1/2" BLK UNION  
U-B 1322 2 " BLK UNION

## STANDARD MERCHANT COUPLINGS



U-B 1418 1/8" BLK COUPLING  
U-B 1420 1/4" BLK COUPLING  
U-B 1422 3/8" BLK COUPLING  
U-B 1424 1/2" BLK COUPLING  
U-B 1426 3/4" BLK COUPLING  
U-B 1428 1" BLK COUPLING  
U-B 1430 1 1/4" BLK COUPLING  
U-B 1432 1 1/2" BLK COUPLING  
U-B 1434 2" BLK COUPLING

*Serving the LP Industry*

*Since 1954*

TABLE OF CONTENTS

1-800-457-3826

31

*Building Relationships*

*is our utmost reward*

# PETROLEUM TANK CORP

## BLACK PIPE NIPPLES

### SCHEDULE 40 PIPE NIPPLES



U-B 1502	1/8" x CLOSE BLK. NIPPLE
U-B 1504	1/8" x 1 1/2" BLK. NIPPLE
U-B 1506	1/8" x 2" BLK. NIPPLE
U-B 1508	1/8" x 2 1/2" BLK. NIPPLE
U-B 1510	1/8" x 3" BLK. NIPPLE
U-B 1522	1/8" x 6" BLK. NIPPLE
U-B 1554	1/4" x CLOSE BLK NIPPLE
U-B 1558	1/4" x 2" BLK NIPPLE
U-B 1562	1/4" x 3" BLK NIPPLE
U-B 1566	1/4" x 4" BLK NIPPLE
U-B 1570	1/4" x 5" BLK NIPPLE
U-N 1574	1/4" x 6" BLK NIPPLE
U-B 1606	3/8" x CLOSE BLK NIPPLE
U-B 1610	3/8" x 2" BLK NIPPLE
U-B 1614	3/8" x 3" BLK NIPPLE
U-B 1616	3/8" x 3 1/2" BLK NIPPLE
U-B 1618	3/8" x 4" BLK NIPPLE
U-B 1622	3/8" x 5" BLK NIPPLE
U-B 1626	3/8" x 6" BLK NIPPLE
U-B 1652	1/2" x CLOSE BLK NIPPLE
U-B 1656	1/2" x 2" BLK NIPPLE
U-B 1660	1/2" x 3" BLK NIPPLE
U-B 1664	1/2" x 4" BLK NIPPLE
U-B 1668	1/2" x 5" BLK NIPPLE
U-B 1672	1/2" x 6" BLK NIPPLE
U-B 1696	1/2" x 12" BLK NIPPLE
U-B 1704	3/4" x CLOSE BLK NIPPLE
U-B 1706	3/4" x 1 1/2" GALV. NIPPLE
U-B 1708	3/4" x 2" BLK NIPPLE
U-B 1712	3/4" x 3" BLK NIPPLE
U-B 1716	3/4" x 4" BLK NIPPLE
U-B 1720	3/4" x 5" BLK NIPPLE
U-B 1724	3/4" x 6" BLK NIPPLE
U-B 1756	1" x CLOSE BLK NIPPLE
U-B 1758	1" x 2" BLK NIPPLE
U-B 1762	1" x 3" BLK NIPPLE
U-B 1766	1" x 4" BLK NIPPLE
U-B 1770	1" x 5" BLK NIPPLE
U-B 1774	1" x 6" BLK NIPPLE
U-B 1798	1" x 12" BLK NIPPLE

*Serving the LP Industry*

*Since 1954*

**TABLE OF CONTENTS**

**1-800-457-3826**

*Building Relationships*

*is our utmost reward*



# PETROLEUM TANK CORP

## BLACK PIPE NIPPLES



### SCHEDULE 40 PIPE NIPPLES

U-B 1806	1 1/4" x CLOSE BLK NIPPLE
U-B 1808	1 1/4" x 2" BLK NIPPLE
U-B 1812	1 1/4" x 3" BLK NIPPLE
U-B 1816	1 1/4" x 4" BLK NIPPLE
U-B 1820	1 1/4" x 5" BLK NIPPLE
U-B 1824	1 1/4" x 6" BLK NIPPLE
U-B 1856	1 1/2" x CLOSE BLK NIPPLE
U-B 1874	1 1/2" x 6" BLK NIPPLE
U-B 1906	2" x CLOSE BLK NIPPLE
U-B 1914	2" x 3" BLK NIPPLE
U-B 1918	2" x 4" BLK NIPPLE

### ASSORTED NIPPLE KITS

U-B 2608	1/2 " BLK NIPPLE KIT
U-B 2610	3/4" BLK NIPPLE KIT

## FORGED STEEL FITTINGS



CAP 1/4" COUP	SCHEDULE 80 COUPLING
CAP 3/8" COUP	SCHEDULE 80 COUPLING
CAP 1/2" COUP	SCHEDULE 80 COUPLING
CAP 3/4" COUP	SCHEDULE 80 COUPLING
CAP 1" COUP	SCHEDULE 80 COUPLING
CAP 1 1/4" COUP	SCHEDULE 80 COUPLING
CAP 1 1/2" COUP	SCHEDULE 80 COUPLING
CAP 2" COUP	SCHEDULE 80 COUPLING

### SCHEDULE 80 PLUGS



CAP 1/4" PLUG	SCHEDULE 80 PLUG
CAP 3/8" PLUG	SCHEDULE 80 PLUG
CAP 1/2" PLUG	SCHEDULE 80 PLUG
CAP 3/4" PLUG	SCHEDULE 80 PLUG
CAP 1" PLUG	SCHEDULE 80 PLUG
CAP 1 1/4" PLUG	SCHEDULE 80 PLUG
CAP 1 1/2" PLUG	SCHEDULE 80 PLUG
CAP 2" PLUG	SCHEDULE 80 PLUG
CAP 3" PLUG	SCHEDULE 80 PLUG

### SCHEDULE 80 CROSS



CAP 3/4" CROSS	SCHEDULE 80 CROSS
----------------	-------------------

*Serving the LP Industry*

*Building Relationships*

*Since 1954*

*1-800-457-3826*

*is our utmost reward*

# PETROLEUM TANK CORP

## FORGED STEEL FITTINGS

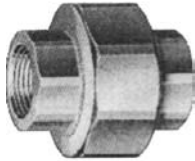

CAP 1/4" UNION	SCHEDULE 80 UNION
CAP 1/2" UNION	SCHEDULE 80 UNION
CAP 3/4" UNION	SCHEDULE 80 UNION
CAP 1" UNION	SCHEDULE 80 UNION
CAP 1 1/4" UNION	SCHEDULE 80 UNION
CAP 1 1/2" UNION	SCHEDULE 80 UNION
CAP 2" UNION	SCHEDULE 80 UNION
CAP 3" UNION	SCHEDULE 80 UNION

### SCHEDULE 80 UNIONS



CAP 1/4" x CL NIP	SCHEDULE 80 CLOSE NIPPLE
CAP 3/4" x CL NIP	SCHEDULE 80 CLOSE NIPPLE
CAP 1" x CL NIP	SCHEDULE 80 CLOSE NIPPLE
CAP 1 1/4" x CL NIP	SCHEDULE 80 CLOSE NIPPLE
CAP 1 1/2" x CL NIP	SCHEDULE 80 CLOSE NIPPLE
CAP 2" x CL NIP	SCHEDULE 80 CLOSE NIPPLE
CAP 3" x CL NIP	SCHEDULE 80 CLOSE NIPPLE

### SCHEDULE 80 CLOSE NIPPLES



CAP 1/4" 45D ELL	SCHEDULE 80, 45 DEGREE ELBOW
CAP 1/2" 45D ELL	SCHEDULE 80, 45 DEGREE ELBOW
CAP 3/4" 45D ELL	SCHEDULE 80, 45 DEGREE ELBOW
CAP 1" 45D ELL	SCHEDULE 80, 45 DEGREE ELBOW
CAP 1 1/4" 45D ELL	SCHEDULE 80, 45 DEGREE ELBOW
CAP 1 1/2" 45 D ELL	SCHEDULE 80, 45 DEGREE ELBOW
CAP 2" 45D ELL	SCHEDULE 80, 45 DEGREE ELBOW

### SCHEDULE 80 - 45 DEGREE ELBOWS



CAP 1/4" 90D ELL	SCHEDULE 80 ELBOW
CAP 3/8" 90D ELL	SCHEDULE 80, 90 DEGREE ELBOW
CAP 1/2" 90D ELL	SCHEDULE 80, 90 DEGREE ELBOW
CAP 3/4" 90D ELL	SCHEDULE 80, 90 DEGREE ELBOW
CAP 1" 90D ELL	SCHEDULE 80, 90 DEGREE ELBOW
CAP 1 1/4" 90D ELL	SCHEDULE 80, 90 DEGREE ELBOW
CAP 1 1/2" 90D ELL	SCHEDULE 80, 90 DEGREE ELBOW
CAP 2" 90D ELL	SCHEDULE 80, 90 DEGREE ELBOW

### SCHEDULE 80 - 90 DEGREE ELBOWS



CAP 1/4" TEE	SCHEDULE 80 TEE
CAP 1/2" TEE	SCHEDULE 80 TEE
CAP 3/4" TEE	SCHEDULE 80 TEE
CAP 1" TEE	SCHEDULE 80 TEE
CAP 1 1/4" TEE	SCHEDULE 80 TEE
CAP 1 1/2" TEE	SCHEDULE 80 TEE

### SCHEDULE 80 TEE'S

*Serving the LP Industry*

*Since 1954*

TABLE OF CONTENTS

1-800-457-3826

*Building Relationships*

*is our utmost reward*

# PETROLEUM TANK CORP

## FORGED STEEL FITTINGS



### SCHEDULE 80 SWAGE NIPPLES

CAP 1" x 1/2" SW NIP	SCHEDULE 80 SWAGE NIPPLE
CAP 1" x 3/4" SW NIP	SCHEDULE 80 SWAGE NIPPLE
CAP 3/4" x 1/2" SW NIP	SCHEDULE 80 SWAGE NIPPLE
CAP 3/4" x 1" SW NIP	SCHEDULE 80 SWAGE NIPPLE
CAP 1 1/4" x 3/4" SW NIP	SCHEDULE 80 SWAGE NIPPLE
CAP 1 1/4" x 1" SW NIP	SCHEDULE 80 SWAGE NIPPLE
CAP 3" x 2" SW NIP	SCHEDULE 80 SWAGE NIPPLE

### SCHEDULE 80 REDUCING BUSHINGS



CAP 1/2" x 1/4" HB	SCHEDULE 80 REDUCING BUSHING
CAP 3/4" x 1/4" HB	SCHEDULE 80 REDUCING BUSHING
CAP- 3/4" x 1/2" HB	SCHEDULE 80 REDUCING BUSHING
CAP 1" x 1/4" HB	SCHEDULE 80 REDUCING BUSHING
CAP 1" x 3/8" HB	SCHEDULE 80 REDUCING BUSHING
CAP 1" x 1/2" HB	SCHEDULE 80 REDUCING BUSHING
CAP 1" x 3/4" HB	SCHEDULE 80 REDUCING BUSHING
CAP 1 1/4" x 1/4" HB	SCHEDULE 80 REDUCING BUSHING
CAP 1 1/4" x 3/8" HB	SCHEDULE 80 REDUCING BUSHING
CAP 1 1/4" x 1/2" HB	SCHEDULE 80 REDUCING BUSHING
CAP 1 1/4" x 3/4" HB	SCHEDULE 80 REDUCING BUSHING
CAP 1 1/4" x 1" HB	SCHEDULE 80 REDUCING BUSHING
CAP 1 1/2" x 1/4" HB	SCHEDULE 80 REDUCING BUSHING
CAP 1 1/2" x 1/2" HB	SCHEDULE 80 REDUCING BUSHING
CAP 1 1/2" x 3/4" HB	SCHEDULE 80 REDUCING BUSHING
CAP 1 1/2" x 1" HB	SCHEDULE 80 REDUCING BUSHING
CAP 1 1/2" x 1 1/4" HB	SCHEDULE 80 REDUCING BUSHING
CAP 2" x 1/4" HB	SCHEDULE 80 REDUCING BUSHING
CAP 2" x 1/2" HB	SCHEDULE 80 REDUCING BUSHING
CAP 2" x 3/4" HB	SCHEDULE 80 REDUCING BUSHING
CAP 2" x 1" HB	SCHEDULE 80 REDUCING BUSHING
CAP 2" x 1 1/4" HB	SCHEDULE 80 REDUCING BUSHING
CAP 2" x 1 1/2" HB	SCHEDULE 80 REDUCING BUSHING

## SCH 80 PIPE NIPPLES



### SCHEDULE 80 PIPE NIPPLES

CAP 1/4"	1/4" X (1 1/2" THRU 6")
CAP 1/2"	1/2" X (2" THRU 6")
CAP 3/4"	3/4" X (1 1/2" THRU 8")
CAP 1"	1" X (2" , 2 1/2", 4", 6")

*Serving the LP Industry*

*Since 1954*

**TABLE OF CONTENTS**

**1-800-457-3826**

**35**

*Building Relationships*

*is our utmost reward*

# PETROLEUM TANK CORP

## SCH 80 PIPE NIPPLES



CAP 1 1/4"	1 1/4" X (2", 2 1/2", 3", 3 1/2", 4")
CAP 1 1/2"	1 1/2" X (2" THRU 6")
CAP 2"	2" X (2" THRU 6")
CAP 3"	3" X (2" THRU 6")

## SCHEDULE 80 PIPE NIPPLES

## BALL VALVES



LEG 102	3/8" FNPT x 3/8" FNPT
LEG 103	1/2" FNPT x 1/2" FNPT
LEG 104	3/4" FNPT x 3/4" FNPT



LEG 113	1/2" FL. x 1/2" FNPT
LEG 115	15/16"-16 FL. x 3/4" FNPT



LEG 213	1/2" FL. x 1/2" MNPT
---------	----------------------



LEG 312	3/8" FL. x 3/8" FL.
LEG 313	1/2" FL. x 1/2" FL.
LEG 314	5/8" FL. x 5/8" FL.



LEG 513	1/2" FNPT x 1/2" FNPT, WITH TAP
LEG 514	3/4" FNPT x 3/4" FNPT, WITH TAP
LEG 515	1" FNPT x 1" FNPT, WITH TAP



LEG 522	3/8" FL. x 3/8" FL., WITH TAP
LEG 523	1/2" FL. x 1/2" FL., WITH TAP
LEG 524	5/8" FL. x 5/8" FL., WITH TAP

## BLUE TOP GAS BALL VALVES

## BRASS BALL VALVES



LEG 80-101-01	1/4" BALL VALVE
LEG 80-102-01	3/8" BALL VALVE
LEG 80-103-01	1/2" BALL VALVE
LEG 80-104-01	3/4" BALL VALVE
LEG 80-105-01	1" BALL VALVE
LEG 80-106-01	1 1/4" BALL VALVE
LEG 80-107-01	1 1/2" BALL VALVE
LEG 80-108-01	2" BALL VALVE
LEG 80-100-01	3" BALL VALVE



## STAINLESS STEEL BALL VALVES

LEG 146	1 1/4" STAINLESS STEEL BALL VALVE
LEG 147	1 1/2" STAINLESS STEEL BALL VALVE
LEG 148	2" STAINLESS STEEL BALL VALVE

*Serving the LP Industry*

*Since 1954*

TABLE OF CONTENTS

1-800-457-3826

36

*Building Relationships*

*is our utmost reward*

# PETROLEUM TANK CORP

## AIR MIXERS



JSN LAO160	1/2" AIR MIXER
JSN LAO161	3/4" AIR MIXER
JSN LAO165	1" AIR MIXER
JSN LAO166	1 1/4" AIR MIXER

## AIR MIXERS

## COOKER VALVES



MIS PCVFC 1/8"

## FISH COOKER VALVE



MIS PCV 1/4"

## PIG COOKER VALVES



MIS PCVBH 3/8" x 1/4"

## CYLINDERS



WOR 1004.5-OPD 4.5# CYLINDER, WITH OPD VALVE

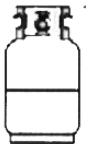

WOR 1011-OPD 11# CYLINDER, WITH OPD VALVE



WOR 1020-OPD 20# CYLINDER, WITH OPD VALVE



WOR 1030-OPD 30# CYLINDER, WITH OPD VALVE

## CYLINDERS

*Serving the LP Industry*

*Building Relationships*

*Since 1954*

*1-800-457-3826*

*is our utmost reward*

# PETROLEUM TANK CORP

## CYLINDERS

## CYLINDERS



WOR 1040-OPD

40# CYLINDER, WITH OPD VALVE



WOR 10100  
WOR 10100MV

100# CYLINDER, W/STANDARD VALVE  
100# CYLINDER, W/STANDARD VALVE

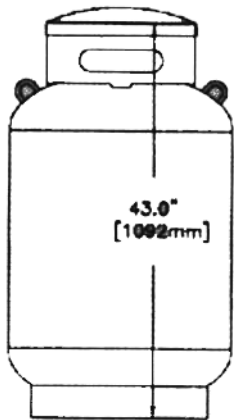

WOR 10200

200# CYLINDER

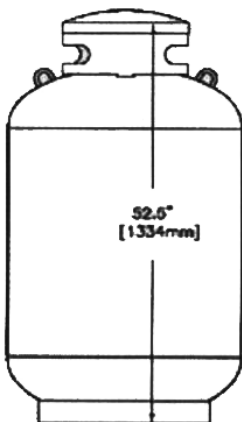

WOR 10420

420# CYLINDER

*Serving the LP Industry*

*Since 1954*

**TABLE OF CONTENTS**

**1-800-457-3826**

38

*Building Relationships*

*is our utmost reward*

# PETROLEUM TANK CORP

## CYLINDERS

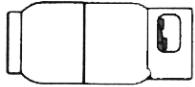

WOR 3301C  
WOR AL3301C

## FORK LIFT CYLINDERS

33.5# STEEL CYLINDER  
33.5# ALUMINUM CYLINDER



WOR 2001C  
WOR AL2001C

20# STEEL BUFFER CYLINDER  
20# ALUMINUM BUFFER CYLINDER

## ASME TANKS

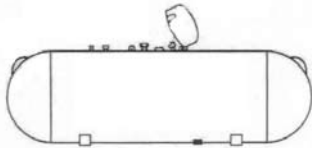

TRIN 120AG  
TRIN 120AG/UG

120 GALLON ABOVE GROUND TANK  
120 GALLON ABOVE/UNDER GROUND TANK

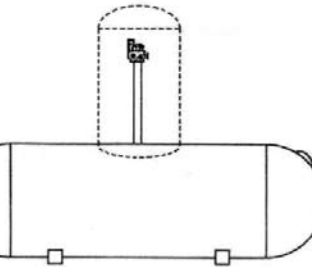

TRIN 250AG

250 GALLON ABOVE GROUND TANK

TRIN 320AG  
TRIN 320AG/UG  
TRIN 320UG

320 GALLON ABOVE GROUND TANK  
320 GALLON ABOVE/UNDER GROUND TANK  
320 GALLON UNDER GROUND TANK

TRIN 500AG  
TRIN 500AG/UG  
TRIN 500UG

500 GALLON ABOVE GROUND TANK  
500 GALLON ABOVE/UNDER GROUND TANK  
500 GALLON UNDER GROUND TANK

TRIN 1000AG  
TRIN 1000AG/UG  
TRIN 1000UG

1000 GALLON ABOVE GROUND TANK  
1000 GALLON ABOVE/UNDER GROUND TANK  
1000 GALLON UNDER GROUND TANK

## LIDS

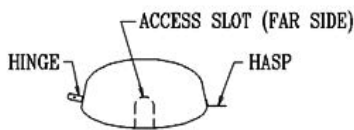

TRIN A/G

LID FOR AG TANK

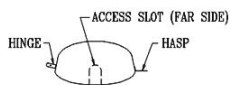

TRIN AG/UG

LID FOR AG/UG TANK

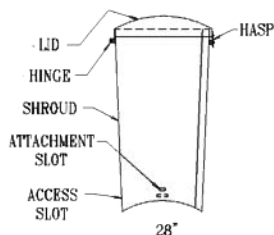

TRIN UG DOME

LID & DOME FOR UG TANK, TALL RISER

*Serving the LP Industry*

*Building Relationships*

*Since 1954*

1-800-457-3826

*is our utmost reward*

# PETROLEUM TANK CORP

## TANK WRENCHES

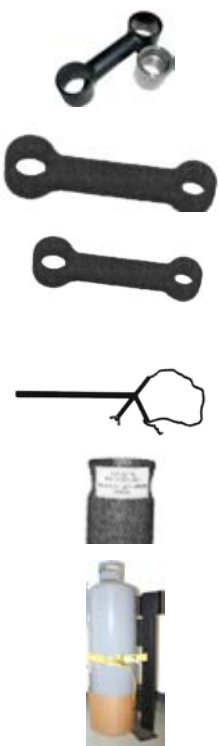

M/E MEP 122 QCC WRENCH - 2 PIECE

M/E MEP 125 SOCKET EXTENSION CROW FOOT

PET 20-2 CYLINDER WRENCH

PET 20-4 CHAIN VISE ASSEMBLY

PET 20-8 VALVE TOOL

## TANK WRENCHES

### CYLINDER VISE

PET CV100 CYLINDER VISE FOR REMOVING TANK VALVES

## GAS LEAK DETECTORS



SEN GOLD CGI GAS DETECTOR, EX/CO/O2, ALL IN ONE

SEN HXG-2D COMBUSTABLE GAS LEAK DETECTOR W/DIGITAL DISPLAY

### ATMOSPHERE & GAS LEAK DETECTION

## CATHODIC PROTECTION



MES 9MA H-1 GRADE A, 9LB MAGNESIUM ANODE, WITH 10 FT, #12 TW WIRE, W/ 3/8" RING TERMINAL, FOR TANKS UP TO 320 GALLONS.

MES 17MA H-1 GRADE A, 17LB MAGNESIUM ANODE, WITH 10 FT, #12 TW WIRE, W/ 3/8" RING TERMINAL, FOR TANKS 500 GALLON AND ABOVE.

SEN CP KIT CORROSION DETECTION KIT, W/DIGITAL MULTI METER TO TEST PIPE TO SOIL POTENTIALS

### MAGNESIUM PROTECTION

*Serving the LP Industry*

*Since 1954*

TABLE OF CONTENTS

1-800-457-3826

*Building Relationships*

*is our utmost reward*



# PETROLEUM TANK CORP

## GAUGES



ROC 120B  
ROC 200B  
ROC 320B  
ROC 420B  
ROC 500B  
ROC 1000B

## FLOAT GAUGES

BOLT IN TYPE FOR 24" DIA, 120GAL TANK  
BOLT IN TYPE FOR 220# VERTICAL TANK  
BOLT IN TYPE FOR 30" DIA.250/320 TANK  
BOLT IN TYPE FOR 420# VERTICAL TANK  
BOLT IN TYPE FOR 37" DIA, 500 GAL TANK  
BOLT IN TYPE FOR 41 DIA,1000 GAL TANK



ROC 120S114  
ROC 200S114  
ROC 320S114  
ROC 420S114  
ROC 500S114  
ROC 1000S114

1 1/4" SCREW TYPE FOR 24" DIA, 120GAL TANK  
1 1/4" SCREW TYPE FOR 220# VERTICAL TANK  
1 1/4" SCREW TYPE FOR 30" DIA.250/320 TANK  
1 1/4" SCREW TYPE FOR 420# VERTICAL TANK  
1 1/4" SCREW TYPE FOR 37" DIA, 500 GAL TANK  
1 1/4" SCREW TYPE FOR 41" DIA, 1000 GAL TANK



ROC 120S1  
ROC 200S1  
ROC 320S1  
ROC 420S1  
ROC 500S1  
ROC 1000S1

1" SCREW TYPE FOR 24" DIA, 120GAL TANK  
1" SCREW TYPE FOR 220# VERTICAL TANK  
1" SCREW TYPE FOR 30" DIA.250/320 TANK  
1" SCREW TYPE FOR 420# VERTICAL TANK  
1" SCREW TYPE FOR 37" DIA, 500 GAL TANK  
1" SCREW TYPE FOR 41 DIA,1000 GAL TANK

## GAUGES FOR LIFT TRUCK CYLINDERS

ROC 7384-1006  
ROC 7284-34

THREADED GAUGE, 3/4", 33.5 CYLINDER  
THREADED GAUGE, 1 1/4", 33.4 CYLINDER



ROC 5-1  
ROC 5-39

SR. DIAL SIZE, ASME ABOVE GROUND TANK  
JR. DIAL SIZE, ASME & LIFT TRUCK TANKS



ROC 5-41  
ROC 5-1951  
ROC 5-1992  
ROC 5-2591  
ROC 5-2772

JR. DIAL SIZE, ASME UNDERGROUND TANKS  
SNAP ON DIAL, 420# VERTICAL TANK  
1 1/4" DIAL SIZE, 33.5 GAL. LIFT TRUCK CYLINDER  
JR. DIAL SIZE, ASME ABOVE GROUND TANK  
SNAP ON DIAL, VERTICAL DOT TANK



ROC 3181S17-39  
ROC 3181S17-36

## UNIVERSAL DIAL KITS

UNIVERSAL DIAL KIT  
SR. UNIVERSAL DIAL KIT

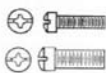

ROC 40-414  
ROC 40-415

SCREWS FOR JR. HEAD  
SCREWS FOR SR. HEAD



ROC 5-7  
ROC 5-4

GASKET FOR JR. HEAD  
GASKET FOR SR. HEAD

*Serving the LP Industry*

*Building Relationships*

*Since 1954*

*1-800-457-3826*

*is our utmost reward*

# PETROLEUM TANK CORP

## GAUGES



ROC M6339-11-72  
ROC M6339-11-79  
ROC 6342-11-108  
ROC 6342-11-130

### MAGNETEL FLOAT GAUGES

4" DIAL GAUGE FOR 72" DIA. TANK  
4" DIAL GAUGE FOR 79" DIA. TANK  
8" DIAL GAUGE FOR 108" DIA. TANK  
8" DIAL GAUGE FOR 130" DIA. TANK



NIS PG015  
NIS PG030  
NIS PG060  
NIS PG 0100  
NIS PG0300BM  
NIS PG060L  
NIS PG0300  
NIS PG0300L  
NIS PG035H

### PRESSURE GAUGES

2", 15 PSIG MAX PRESSURE GAUGE  
2", 30 PSIG MAX PRESSURE GAUGE  
2", 60 PSIG MAX PRESSURE GAUGE  
2", 100 PSIG MAX PRESSURE GAUGE  
2", 300 PSIG MAX PRESSURE GAUGE  
2", 60 PSIG, LIQUID FILLED GAUGE  
2 1/2", 300 PSIG GAUGE  
2 1/2", 300 PSIG, LIQUID FILLED GAUGE  
2 1/2", 35" WC GAUGE



TRE B83104-02  
TRE B83104-08

### TEMPERATURE GAUGE

160 DEGREE, 4" STEM LENGTH  
500 DEGREE, 4" STEM LENGTH



M/B G-2004

### MANOMETER

MANOMETER KIT, 16" WATER COLUMN



M/E ME50P-2  
M/E ME50P-5

### LOW PRESSURE TEST KIT

LOW PRESSURE TEST KIT, 0-35"WC  
LOW PRESSURE TEST GAUGE & HOSE ONLY



M/E ME1328  
M/E ME1331  
M/E ME1332

### LOW PRESSURE TEST ADAPTORS

3/8" F FL. x 3/8" M FL. x 1/2" HOSE BARB  
1/2" F FL. x 1/2" M FL. x 1/2" HOSE BARB  
5/8" F FL. x 1/2" M FL. x 1/2" HOSE BARB



M/E MEJ595  
M/E MEJ600  
M/E MEJ601

### HIGH PRESSURE TEST BLOCKS

1/2" MNPT x 1/2" FNPT ADAPTOR ONLY  
M POL x F POL, HIGH PRESSURE, 300PSIG  
M POL x F POL, HIGH PRESSURE W/ VENT

*Serving the LP Industry*

*Since 1954*

TABLE OF CONTENTS

1-800-457-3826

42

*Building Relationships*

*is our utmost reward*

# PETROLEUM TANK CORP

## TUBING



TUB 1/8 X 50 COP	1/8" OD COPPER TUBING, 50 FT LG.
TUB 3/16 X 50 COP	3/16" OD COPPER TUBING, 50 FT LG.
TUB 1/4 X 50 COP	1/4" OD COPPER TUBING, 50 FT LG.
TUB 5/16 X 50 COP	5/16" OD COPPER TUBING, 50 FT LG.
TUB 3/8 X 50 COP	3/8" OD COPPER TUBING, 50 FT LG.
TUB 1/2 X 50 COP	1/2" OD COPPER TUBING, 50 FT LG.
TUB 5/8 X 50 COP	5/8" OD COPPER TUBING, 50 FT LG.
TUB 1/4 X 60K	1/4", ID TYPE K, COPPER TUBING, 60 FT LG.
TUB 3/8 X 60K	3/8", ID TYPE K, COPPER TUBING, 60 FT LG.
TUB 1/2 X 60K	1/2", ID TYPE K, COPPER TUBING, 60 FT LG.

### COPPER TUBING

### POLYETHYLENE-COATED COPPER TUBING



KAM 13850	3/8" OD X 50 FT GAS-TEC
KAM 11210	1/2" OD X 100 FT GAS-TEC
KAM 11250	1/2" OD X 50 FT GAS-TEC
KAM 15850	5/8" OD X 50 FT GAS-TEC

### ALUMINUM TUBING



TUB 1/8 X 50 ALUM	1/8" OD ALUMINUM TUBING X 50 FT LG.
TUB 3/16 X 50 ALUM	3/16" OD ALUMINUM TUBING X 50 FT LG.
TUB 1/4 X 50 ALUM	1/4" OD ALUMINUM TUBING X 50 FT LG.
TUB 3/8 X 50 ALUM	3/8" OD ALUMINUM TUBING X 50 FT LG.
TUB 7/16 X 50 ALUM	7/16" OD ALUMINUM TUBING X 50 FT LG.
TUB 1/2 X 50 ALUM	1/2" OD ALUMINUM TUBING X 50 FT LG.

### TUBING "J" CLIPS



HLY 319-8	1/2" OD TUBING CLIP
HLY 319-10	5/8" OD TUBING CLIP

### SPRING TUBING BENDERS



I/C 102F06	3/8" TUBING BENDER
I/C 102F08	1/2" TUBING BENDER
I/C 102F10	5/8" TUBING BENDER

### TUBING CUTTERS



EMP 2812	7/8" MINI TUBING CUTTER
I/C TC1000	TUBING CUTTER
EMP 2821	TUBING CUTTER
EMP 2826	TUBING CUTTER
ROT 70010	TUBING CUTTER
I/C 312FC	TUBING CUTTER, 1/8" TO 1 1/8" OD

*Serving the LP Industry*

*Building Relationships*

*Since 1954*

*1-800-457-3826*

*is our utmost reward*

# PETROLEUM TANK CORP

## TUBING TOOLS



BRM 10718 PLASTIC TUNING SHEARS, 0 - 26 MM



ROT 26033 FLARING TOOL, 3/16", 1/4", 5/16", 3/8", 1/2", 5/8"



P/H 945-TH ROLOFLARE FLARING TOOL



TUBING BENDERS  
ROT 25136 5/8" STANDARD TUBING BENDER  
ROT 25142 1/2" STANDARD TUBING BENDER



EMP 2886 3-IN-1 TUBING BENDER

## THREAD SEALER



CRN SS04 1/4 PINT, GASOILA SOFT-SET  
CRN SS08 1/2 PINT, GASOILA SOFT-SET  
CRN SS16 1 PINT, GASOILA SOFT-SET



CRN PB04 1/4 PINT, JOHN CRANE SEALING COMPOUND  
CRN PB16 1 PINT, JOHN CRANE SEALING COMPOUND



CRN ZT21 1/2" WIDE x 520" TEFLON TAPE  
CRN ZT51 1" WIDE x 520" TEFLON TAPE  
BRM 13219 1/2" WIDE x 520" TEFLON TAPE

## LEAK DETECTOR



WIN ED1 1 PINT EMPTY BOTTLE W/BRUSH  
WIN LD16 1 PINT, LOW TEMPERATURE  
WIN LDI 1 GALLON, LOW TEMPERATURE

## METHANOL



### METHANOL

S/C METHANOL-55 55 GALLON DRUM OF METHANOL

### METHANOL INJECTOR

M/E MEP700 METHANOL INJECTOR

*Serving the LP Industry*

*Since 1954*

TABLE OF CONTENTS

1-800-457-3826

*Building Relationships*

*is our utmost reward*

# PETROLEUM TANK CORP

## APPLIANCE CONNECTOR

### COMMERCIAL CONNECTORS

DOR H5036P 1/2" X 36" COMM. APPLIANCE CONNECTOR  
DOR H5048P 1/2" X 48" COMM. APPLIANCE CONNECTOR  
DOR H5060P 1/2" X 60" COMM. APPLIANCE CONNECTOR  
DOR H5072P 1/2" X 72" COMM. APPLIANCE CONNECTOR



DOR H7512P 3/4" X 12" COMM. APPLIANCE CONNECTOR  
DOR H7524P 3/4" X 24" COMM. APPLIANCE CONNECTOR  
DOR H7536P 3/4" X 36" COMM. APPLIANCE CONNECTOR  
DOR H7548P 3/4" X 48" COMM. APPLIANCE CONNECTOR  
DOR H7560P 3/4" X 60" COMM. APPLIANCE CONNECTOR  
DOR H7572P 3/4" X 72" COMM. APPLIANCE CONNECTOR

DOR H10036P 1" X 36" COMM. APPLIANCE CONNECTOR  
DOR H10048P 1" X 48" COMM. APPLIANCE CONNECTOR  
DOR H10060P 1" X 60" COMM. APPLIANCE CONNECTOR  
DOR H10072P 1" X 72" COMM. APPLIANCE CONNECTOR

### SNAPFAST QUICK DISCONNECT



DOR HQD50 1/2" QUICK DISCONNECT  
DOR HQD75 3/4" QUICK DISCONNECT  
DOR HQD100 1" QUICK DISCONNECT

### ANCHOR KITS



DOR RDC-36 36" ANCHOR KIT  
DOR RDC48 48" ANCHOR KIT  
DOR RDC-60 60" ANCHOR KIT

### RESIDENTIAL CONNECTORS

DOR 3SS12 3/8" X 12" STAINLESS STEEL APPL. CONNECTOR  
DOR 3SS18 3/8" X 18" STAINLESS STEEL APPL. CONNECTOR  
DOR 3SS24 3/8" X 24" STAINLESS STEEL APPL. CONNECTOR  
DOR 3SS36 3/8" X 36" STAINLESS STEEL APPL. CONNECTOR

DOR 4SS12 1/2" X 12" STAINLESS STEEL APPL. CONNECTOR  
DOR 4SS18 1/2" X 18" STAINLESS STEEL APPL. CONNECTOR  
DOR 4SS24 1/2" X 24" STAINLESS STEEL APPL. CONNECTOR  
DOR 4SS36 1/2" X 36" STAINLESS STEEL APPL. CONNECTOR  
DOR 4SS48 1/2" X 48" STAINLESS STEEL APPL. CONNECTOR  
DOR 4SS60 1/2" X 60" STAINLESS STEEL APPL. CONNECTOR



DOR 7SS24 5/8" X 24" STAINLESS STEEL APPL. CONNECTOR  
DOR 7SS36 5/8" X 36" STAINLESS STEEL APPL. CONNECTOR  
DOR 7SS48 5/8" X 48" STAINLESS STEEL APPL. CONNECTOR  
DOR 7SS60 5/8" X 60" STAINLESS STEEL APPL. CONNECTOR

*Serving the LP Industry*

*Building Relationships*

*Since 1954*

*1-800-457-3826*

*is our utmost reward*

# PETROLEUM TANK CORP

## **POLY PIPE - GAS PIPE**



CPC P50C  
CPC P75I  
CPC P100I  
CPC P125I  
CPC P200I-250  
CPC P200I

## PLASTIC PIPE

1/2" CTS X 500' PIPE  
3/4" IPS X 500' PIPE  
1" IPS X 500' PIPE  
1 1/4" IPS X 500' PIPE  
2" IPS X 250' PIPE  
2" IPS X 500' PIPE



CPC 31000  
CPC 31000MB

## TAPE

WARNING TAPE  
METAL BACK TAPE



CPC TW1000

## TRACE WIRE

TRACE WIRE, 1000FT.



CPC SC50C  
CPC SC75I  
CPC SC100I  
CPC SC125I  
CPC 200I

## SOCKET COUPLING

1/2" CTS  
3/4" IPS  
1" IPS  
1 1/4" IPS  
2" IPS



CPC RC7550C  
CPC RC10050RC  
CPC RC10075I  
CPC RC12575I  
CPC RC125100I  
CPC RC200100I  
CPC RC200125I  
CPC RC300200I

## REDUCING COUPLINGS

3/4" IPS X 1/2" CTS  
1" IPS X 1/2" CTS  
1" IPS X 3/4" IPS  
1 1/4" IPS X 3/4" IPS  
1 1/4" IPS X 1" IPS  
2" IPS X 1" IPS  
2" IPS X 1 1/4" IPS  
3" IPS X 2" IPS



CPC ST50C  
CPC ST75I  
CPC ST100I  
CPC ST125I  
CPC ST200I  
CPC ST300I

## SOCKET TEES

1/2" CTS  
3/4" IPS  
1" IPS  
1 1/4" IPS  
2" IPS  
3" IPS

*Serving the LP Industry*

*Since 1954*

**TABLE OF CONTENTS**

**1-800-457-3826**

46

*Building Relationships*

*is our utmost reward*



# PETROLEUM TANK CORP

## POLY PIPE - GAS PIPE



CPC RT10050C

### REDUCING TEE

1" IPS X 1" CTS X 1/2" CTS



CPC SL50C  
CPC SL75I  
CPC SL1-I  
CPC SL125I  
CPC SL200I  
CPC SL300I

### SOCKET ELBOWS

1/2" CTS  
3/4" IPS  
1" IPS  
1 1/4" IPS  
2" IPS  
3" IPS



CPC SEC50C  
CPC SEC75I  
CPC SEC100I  
CPC SEC125I  
CPC SEC200I

### SOCKET END CAP

1/2" CTS  
3/4" IPS  
1" IPS  
1 1/4" IPS  
2" IPS



CPC R50C  
CPC R75I  
CPC R100I  
CPC R125I  
CPC R200I

### ANNODELESS RISERS

3/4" IPS X 1/2" CTS RISER  
3/4" IPS X 3/4" IPS RISER  
1" IPS X 1" IPS RISER  
1 1/4" IPS X 1 1/4" IPS RISER  
2" IPS X 2" IPS RISER

### ANODELESS RISERS W/CON-STAB FITTING



C/I 1350-91-4604-25  
C/I 1353-91-4604-25  
C/I 1450-91-4614-25  
C/I 1553-91-4615-25  
C/I 1752-91-4617-25

3/4" MNPT X 1/2" CTS (5/8" OD)  
3/4" MNPT X 3/4" IPS SDR-11  
1" MNPT X 1" IPS SDR-11  
1 1/4" MNPT X 1 1/4" IPS SDR-10  
2" MNPT X 2" IPS SDR-11

### MECHANICAL FLEX RISERS



C/I 1253-92-1004-36  
C/I 1253-92-1004-66  
C/I 1253-92-1004-84  
C/I 1353-92-1004-36  
C/I 1353-92-1004-60  
C/I 1353-92-1004-84  
C/I 1353-92-1013-36  
C/I 1353-92-1013-60  
C/I 1353-92-1013-84  
C/I 1553-92-1015-36

1/2" MNPT X 1/2" CTS (5/8" OD) .090 X 36" LG. FLEX  
1/2" MNPT X 1/2" CTS (5/8" OD) .090 X 66" LG. FLEX  
1/2" MNPT X 1/2" CTS (5/8" OD) .090 X 84" LG. FLEX  
3/4" MNPT X 1/2" CTS (5/8" OD) .090 X 36" LG. FLEX  
3/4" MNPT X 1/2" CTS (5/8" OD) .090 X 60" LG. FLEX  
3/4" MNPT X 1/2" CTS (5/8" OD) .090 X 84" LG. FLEX  
3/4" MNPT X 3/4" IPS SDR-11 X 36" LG. FLEX  
3/4" MNPT X 3/4" IPS SDR-11 X 60" LG. FLEX  
3/4" MNPT X 3/4" IPS SDR-11 X 84" LG. FLEX  
1 1/4" MNPT X 1 1/4" IPS SDR-10 X 36" LG. FLEX

*Serving the LP Industry*

*Building Relationships*

*Since 1954*

*1-800-457-3826*

*is our utmost reward*

# PETROLEUM TANK CORP

## POLY PIPE - GAS PIPE



CPC T50C  
CPC T75I  
CPC T100I  
CPC T125I  
CPC T200I

3/4" IPS X 1/2" CTS TRANSITION  
3/4" IPS X 3/4" IPS TRANSITION  
1" IPS X 1" IPS TRANSITION  
1 1/4" IPS X 1 1/4" IPS TRANSITION  
2" IPS X 2" IPS TRANSITION

## NON-MECHANICAL TRANSITION FITTINGS

## CON STAB-FITTINGS



C/I 3259-52-1004-00  
C/I 3259-52-1013-00  
C/I 3259-52-1008-00  
C/I 3259-52-1014-00  
C/I 3259-52-1015-00  
C/I 3259-52-1017-00

1/2" CTS (5/8" OD)  
3/4" IPS SDR-11  
1" CTS (1 1/8" OD)  
1" IPS SDR-11  
1 1/4" IPS SDR-10  
2" IPS SDR-11

## FULL COUPLINGS



C/I 3259-54-0804-00  
C/I 3259-54-0805-00  
C/I 3259-54-1304-00  
C/I 3259-54-1404-00

1" CTS (1 1/8" OD) X 1/2" CTS  
1" CTS (1 1/8" OD) X 1/2" CTS (5/8" OD)  
3/4" IPS SDR-11 X 1/2" CTS (5/8" OD)  
1" IPS SDR-11 X 1/2" CTS (5/8" OD)

## REDUCER COUPLINGS



C/I 3259-54-1408-00  
C/I 3259-54-1413-00  
C/I 3259-54-1508-00  
C/I 3259-54-1513-00  
C/I 3259-54-1514-00  
C/I 3259-54-1715-00

1" IPS SDR-11 X 1" CTS (1 1/8" OD)  
1" IPS SDR-11 X 3/4" IPS SDR-11  
1 1/4" IPS SDR-10 X 1" CTS (1 1/8" OD)  
1 1/4" IPS SDR-10 X 3/4" IPS SDR-11  
1 1/4" IPS SDR-10 X 1" IPS SDR-11  
2" IPS SDR-11 X 1 1/4" IPS SDR-10

## REDUCER COUPLINGS



C/I 3259-57-1004-00  
C/I 3259-57-1013-00  
C/I 3259-57-1008-00  
C/I 3259-57-1015-00  
C/I 3259-57-1017-00

1/2" CTS (5/8" OD)  
3/4" IPS SDR-11  
1" CTS (1 1/8" OD)  
1 1/4" IPS SDR-10  
2" IPS SDR-11

## CAP-N-GO COUPLINGS



C/I 3259-53-1004-00  
C/I 3259-53-1013-00  
C/I 3259-53-1008-00  
C/I 3259-53-1014-00  
C/I 3259-53-1015-00  
C/I 3259-53-1017-00

1/2" CTS (5/8" OD)  
3/4" IPS SDR-11  
1" CTS (1 1/8" OD)  
1" IPS SDR-11  
1 1/4" IPS SDDR-10  
2" IPS SDR-11

## END CAPS

*Serving the LP Industry*

*Since 1954*

TABLE OF CONTENTS

1-800-457-3826

48

*Building Relationships*

*is our utmost reward*



# PETROLEUM TANK CORP

## CON STAB-FITTINGS



C/I 3259-51-1004-00	1/2" CTS (5/8" OD)
C/I 3259-51-1013-00	3/4" IPS SDR-11
C/I 3259-51-1008-00	1" CTS (1 1/8" OD)
C/I 3259-51-1014-00	1" IPS SDR-11
C/I 3259-51-1015-00	1 1/4" IPS SDR-10
C/I 3259-51-1017-00	2" IPS SDR-11

### 90 DEGREE ELBOW



C/I 3259-50-1004-00	1/2" CTS (5/8" OD)
C/I 3259-50-1013-00	3/4" IPS SDR-11
C/I 3259-50-1008-00	1" CTS (1 1/8" OD)
C/I 3259-50-1014-00	1" IPS SDR-11
C/I 3259-50-1015-00	1 1/4" IPS SDR-10
C/I 3259-50-1017-00	2" IPS SDR-11

### 3-WAY TEES



C/I 3259-49-1304-00	3/4" IPS SDR-11 X 1/2" CTS (5/8" OD)
C/I 3259-49-0804-00	1" CTS (1 1/8" OD) X 1/2" CTS (5/8" OD)
C/I 3259-49-1404-00	1" IPS SDR-11 X 1/2" CTS (5/8" OD)

### REDUCING TEES



C/I 3259-49-1408-00	1" IPS SDR-11 X 1" CTS (1 1/8" OD)
C/I 3259-49-1413-00	1" IPS SDR-11 X 3/4" IPS SDR-11
C/I 3259-49-1508-00	1 1/4" IPS SDR-10 X 1" CTS (1 1/8" OD)
C/I 3259-49-1708-00	2" IPS SDR-11 X 1" CTS (1 1/8" OD)
C/I 3259-49-1714-00	2" IPS X 1" IPS
C/I 3259-49-1715-00	2" IPS SDR-11 X 1 1/4" IPS SDR-10
C/I 3259-49-0408-00	1/2" CTS (5/8" OD) X 1" CTS (1 1/8" OD)

### REDUCING TEES



C/I 0459-56-1200-00	1/2" CTS (5/8" OD) X 12" LONG
C/I 1359-56-1200-00	3/4" IPS SDR-11 X 12" LONG
C/I 0859-56-1200-00	1" CTS (1 1/8" OD) WALL X 12" LONG
C/I 1459-56-1200-00	1" IPS SDR-11 X 12" LONG
C/I 3238-14-4415-00	1 1/4" SDR-10 X 14" LONG
C/I 3238-14-4417-00	2" IPS SDR-11 X 14" LONG

### REPAIR COUPLINGS

*Serving the LP Industry*

*Building Relationships*

*Since 1954*

*1-800-457-3826*

*is our utmost reward*

# PETROLEUM TANK CORP

## CON STAB-FITTINGS



### TRANSITION COUPLINGS (PE X COPPER)

C/I 9943-99-0062-00	1/2" CTS (5/8" OD) X 1/4" OD COPPER
C/I 9943-99-0063-00	1/2" CTS (5/8" OD) X 3/8" OD COPPER
C/I 9943-99-0064-00	1/2" CTS (5/8" OD) X 1/2" OD COPPER
C/I 9943-99-0064-00	1/2" CTS (5/8" OD) X 5/8" OD COPPER



### TRANSITION COUPLINGS (PE STAB X MNPT)

C/I 0432-00-0912-00	1/2" CTS (5/8" OD) X 1/2" MNPT
C/I 0432-00-0913-00	1/2" CTS (5/8" OD) X 3/4" MNPT
C/I 0832-00-0913-00	1" CTS (1 1/8" OD) X 3/4" MNPT
C/I 0832-00-0914-00	1" CTS (1 1/8" OD) X 1" MNPT
C/I 1332-00-0913-00	3/4" IPS SDR-11 X 3/4" MNPT
C/I 1332-00-0914-00	3/4" IPS SDR-11 X 1" MNPT



### ELIMINATOR SADDLES

C/I 5864-15-1604-00	1 1/4" IPS MAIN X 1/2" CTS (5/8" OD)
C/I 5864-15-1608-00	1 1/4" IPS MAIN X 1" CTS (1 1/8" OD)
C/I 5764-17-1604-00	2" IPS MAIN X 1/2" CTS (5/8" OD)
C/I 5764-17-1613-00	2" IPS MAIN X 3/4" IPS SDR-11
C/I 5764-17-1608-00	2" IPS MAIN X 1" CTS (1 1/8" OD)
C/I 5764-17-1614-00	2" IPS MAIN X 1" IPS SDR-11



### CHAMFER TOOLS

C/I 0000-33-5480-00	1" CTS (1 1/8" OD) X 1/2" CTS (5/8" OD)
C/I 0000-33-5481-00	3/4" IPS X 1/2" CTS (5/8" OD)
C/I 0000-33-5485-00	1 1/4" IPS
C/I 0000-33-5486-00	2" IPS
C/I 0000-33-5514-00	1" IPS X 3/4" IPS
C/I 0000-35-5516-00	1" IPS X 3/4" IPS



# PETROLEUM TANK CORP



OMEGAFLEX® **TracPipe® & CounterStrike®**  
ISO 9001:2000

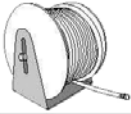

Residential and Commercial

**TracPipe®**  
Flexible Gas Piping by Omega Flex

Component	Material	<b>TracPipe Flexible Gas Piping</b>				
TracPipe Flexible Gas Tubing	Corrugated Stainless Steel 300 Series with Polyethylene Jacket	 	<b>Description</b>	<b>Part Number</b>	<b>Size</b>	<b>Pkg. Qty</b>
			Flexible Piping CSST			<b>REEL LENGTH</b>
		<b>TracPipe 3/8"</b>	FGP-SS4-375-250	3/8"	250 ft/reel	
		<b>TracPipe 3/8"</b>	FGP-SS4-375-100	3/8"	100 ft/reel	
		<b>TracPipe 1/2"</b>	FGP-SS4-500-500	1/2"	500 ft/reel	
		<b>TracPipe 1/2"</b>	FGP-SS4-500-250	1/2"	250 ft/reel	
		<b>TracPipe 1/2"</b>	FGP-SS4-500-100	1/2"	100 ft/reel	
		<b>TracPipe 1/2"</b>	FGP-SS4-500-50	1/2"	50 ft/reel	
		<b>TracPipe 3/4"</b>	FGP-SS4-750-250	3/4"	250 ft/reel	
		<b>TracPipe 3/4"</b>	FGP-SS4-750-100	3/4"	100 ft/reel	
		<b>TracPipe 3/4"</b>	FGP-SS4-750-50	3/4"	50 ft/reel	
		<b>TracPipe 1"</b>	FGP-SS4-100-180	1"	180 ft/reel	
		<b>TracPipe 1"</b>	FGP-SS4-100-100	1"	100 ft/reel	
		<b>TracPipe 1"</b>	FGP-SS4-100-50	1"	50 ft/reel	
	Plywood Reels for Packaging	<b>TracPipe 1 1/4"</b>	FGP-SS4-125-250	1 1/4"	250 ft/reel	
		<b>TracPipe 1 1/4"</b>	FGP-SS4-125-150	1 1/4"	150 ft/reel	
		<b>TracPipe 1 1/2"</b>	FGP-SS4-150-250	1 1/2"	250 ft/reel	
		<b>TracPipe 1 1/2"</b>	FGP-SS4-150-150	1 1/2"	150 ft/reel	
		<b>TracPipe 2"</b>	FGP-SS4-200-150	2"	150 ft/reel	
		<b>Reel Buddy</b>	FGP-Stand	3/8" - 1"	4/box	

Component	Material	<b>CounterStrike – For Enhanced Lightning Protection</b>					
CounterStrike Flexible Gas Tubing	Corrugated Stainless Steel 300 Series with polymer jacket			<b>Description</b>	<b>Part Number</b>	<b>Size</b>	<b>Reel Length</b>
				Flexible Piping CSST			
		<b>CounterStrike 3/8"</b>	FGP-CS-375-250	3/8"	250		
		<b>CounterStrike 3/8"</b>	FGP-CS-375-100	3/8"	100		
		<b>CounterStrike 1/2"</b>	FGP-CS-500-250	1/2"	250		
		<b>CounterStrike 1/2"</b>	FGP-CS-500-100	1/2"	100		
		<b>CounterStrike 3/4"</b>	FGP-CS-750-250	3/4"	250		
		<b>CounterStrike 3/4"</b>	FGP-CS-750-100	3/4"	100		
		<b>CounterStrike 1"</b>	FGP-CS-100-180	1"	180		
		<b>CounterStrike 1"</b>	FGP-CS-100-100	1"	100		
		<b>CounterStrike 1 1/4"</b>	FGP-CS-125-250	1 1/4"	250		
		<b>CounterStrike 1 1/4"</b>	FGP-CS-125-150	1 1/4"	150		
		<b>CounterStrike 1 1/2"</b>	FGP-CS-150-250	1 1/2"	250		
		<b>CounterStrike 1 1/2"</b>	FGP-CS-150-150	1 1/2"	150		
	Plywood Reels for Packaging	<b>CounterStrike 2"</b>	FGP-CS-200-150	2"	150		

CounterStrike is sized exactly the same as conventional TracPipe and uses the same AutoFlare fittings.

Serving the LP Industry







Building Relationships

Since 1954

1-800-457-3826

is our utmost reward

# PETROLEUM TANK CORP

Component	Material	AutoFlare® Fittings						
Straight Mechanical Fitting	Brass Fitting AutoFlare Insert		Description	Part Number	Size			
			Fittings for TracPipe					
			AutoFlare Straight 3/8"	FGP-FST-375N	3/8"(3/8"NPT)			
			AutoFlare Straight 3/8"	FGP-FST-375	3/8"(1/2"NPT)			
			AutoFlare Straight 1/2"	FGP-FST-500	1/2"			
			AutoFlare Reducing 1/2"	FGP-RST500-750	1/2" - 3/4"NPT			
			AutoFlare Straight 3/4"	FGP-FST-750	3/4"			
			AutoFlare Reducing 3/4"	FGP-RST750-500	3/4" - 1/2"NPT			
			AutoFlare Straight 1"	FGP-FST-1000	1"			
			AutoFlare Reducing 1"	FGP-RST1000-750	1" - 3/4"NPT			
Reducing Fitting	Brass		AutoFlare Straight 1-1/4"	FGP-FST-1250	1-1/4"			
			AutoFlare Straight 1-1/2"	FGP-FST-1500	1-1/2"			
			AutoFlare Straight 2"	FGP-FST-2000	2"			
			Spare Split Rings	FGP-RING-375	3/8"			
			Spare Split Rings	FGP-RING-500	1/2"			
			Spare Split Rings	FGP-RING-750	3/4"			
			Spare Split Rings	FGP-RING-1000	1"			
			Spare Split Rings	FGP-RING-1250	1-1/4"			
Split Rings	Brass		Spare Split Rings	FGP-RING-1500	1-1/2"			
			Spare Split Rings	FGP-RING-2000	2"			
			AutoFlare Female Straight 3/8"	FGP-FSTF-375	3/8" - 1/2"NPT			
			AutoFlare Female Straight 1/2"	FGP-FSTF-500	1/2"			
			AutoFlare Female Straight 3/4"	FGP-FSTF-750	3/4"			
			AutoFlare Female Straight 1"	FGP-FSTF-1000	1"			
			Brass Coupling AutoFlare Insert	Brass		Coupling 3/8"	FGP-CPLG-375	3/8"
						Coupling 1/2"	FGP-CPLG-500	1/2"
						Coupling 3/4"	FGP-CPLG-750	3/4"
						Coupling 1"	FGP-CPLG-1000	1"
Coupling 1-1/4"	FGP-CPLG-1250	1-1/4"						
Coupling 1-1/2"	FGP-CPLG-1500	1-1/2"						
Coupling 2"	FGP-CPLG-2000	2"						
Range Fitting 3/8"	FGP-BFF-375	3/8"						
Range Fitting 1/2"	FGP-BFF-500	1/2"						
Range Fitting 3/4"	FGP-BFF-750	3/4"						
Brass Flange Mount Fittings	Brass		Range Fitting 1"	FGP-BFF-1000	1"			
			Range Fitting 1-1/4"	FGP-BFF-1250	1-1/4"			
			Range L Bracket	FGP-TERM-BRAC	All			
			90° Flange Fitting 3/8"	FGP-ELLB-375	3/8"			
			90° Flange Fitting 1/2"	FGP-ELLB-500	1/2"			
			90° Flange Valve 3/8"	FGP-BF90V-375	3/8"			
			90° Flange Valve 1/2"	FGP-BF90V-500	1/2"			
			90° Flange Valve 3/4"	FGP-BF90V-750	3/4"			
			Termination Mount 3/8"	FGP-TM-375	3/8"			
			Termination Mount 1/2"	FGP-TM-500	1/2"			
Termination Mount	Brass and Stainless Steel Plate		Termination Mount 3/4"	FGP-TM-750	3/4"			
			Termination Mount 3/4" x 1/2"	FGP-TM-750-500	3/4" x 1/2"			
			Termination Mount 1"	FGP-TM-1000	1"			
			90° Termination Mount 3/8"	FGP-90TM-375	3/8"			
			90° Termination Mount 1/2"	FGP-90TM-500	1/2"			
			90° Termination Valve 3/8"	FGP-TM90V-375	3/8"			
			90° Termination Valve 1/2"	FGP-TM90V-500	1/2"			
			90° Termination Valve 3/4"	FGP-TM90V-750	3/4"			

2

Serving the LP Industry

Since 1954

TABLE OF CONTENTS



1-800-457-3826

52

Building Relationships

is our utmost reward

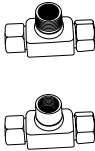
# PETROLEUM TANK CORP

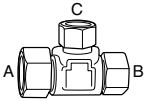
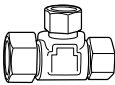
Component	Material	<b>AutoFlare® Tee Fittings</b>																																																																																																								
Tee Fitting	Brass Tee Fitting	<b>TracPipe By Pipe Outlet</b>																																																																																																								
			<table border="1" style="width: 100%; border-collapse: collapse;"> <thead> <tr> <th>Description</th> <th>Part Number</th> <th>Size</th> </tr> </thead> <tbody> <tr> <td>Tee - Male 3/4"</td> <td>FGP-T500-750</td> <td>1/2-3/4" male</td> </tr> <tr> <td>Tee - Female 1/2"</td> <td>FGP-T500-500</td> <td>1/2" Female</td> </tr> <tr> <td>Tee - Female 1/2"</td> <td>FGP-T750-500</td> <td>3/4-1/2" Female</td> </tr> <tr> <td>Tee - Female 3/4"</td> <td>FGP-T750-750</td> <td>3/4" Female</td> </tr> <tr> <td>Tee - Female 1"</td> <td>FGP-T1000-1000</td> <td>1" Female</td> </tr> </tbody> </table>	Description	Part Number	Size	Tee - Male 3/4"	FGP-T500-750	1/2-3/4" male	Tee - Female 1/2"	FGP-T500-500	1/2" Female	Tee - Female 1/2"	FGP-T750-500	3/4-1/2" Female	Tee - Female 3/4"	FGP-T750-750	3/4" Female	Tee - Female 1"	FGP-T1000-1000	1" Female																																																																																					
Description	Part Number	Size																																																																																																								
Tee - Male 3/4"	FGP-T500-750	1/2-3/4" male																																																																																																								
Tee - Female 1/2"	FGP-T500-500	1/2" Female																																																																																																								
Tee - Female 1/2"	FGP-T750-500	3/4-1/2" Female																																																																																																								
Tee - Female 3/4"	FGP-T750-750	3/4" Female																																																																																																								
Tee - Female 1"	FGP-T1000-1000	1" Female																																																																																																								
Reducer Tees	Brass Tee Fitting	<b>TracPipe By TracPipe Outlet</b>																																																																																																								
			<table border="1" style="width: 100%; border-collapse: collapse;"> <tbody> <tr><td>Tee - <b>TracPipe</b> 1/2"</td><td>FGP-TF500-T500</td><td>1/2 x 1/2"</td></tr> <tr><td>Tee - <b>TracPipe</b> 3/4"</td><td>FGP-TF750-T750</td><td>3/4 x 3/4"</td></tr> <tr><td>Tee - <b>TracPipe</b> 1"</td><td>FGP-TF1000T1000</td><td>1 x 1"</td></tr> <tr><td>Tee-Reducer</td><td>FGP-RT-501</td><td>1/2" x 3/8" x 3/8"</td></tr> <tr><td>Tee-Reducer</td><td>FGP-RT-751</td><td>3/4" x 1/2" x 3/8"</td></tr> <tr><td>Tee-Reducer</td><td>FGP-RT-752</td><td>3/4" x 1/2" x 1/2"</td></tr> <tr><td>Tee-Reducer</td><td>FGP-RT-1001</td><td>1" x 3/4" x 1/2"</td></tr> <tr><td>Tee-Reducer</td><td>FGP-RT-1002</td><td>1" x 3/4" x 3/4"</td></tr> <tr><td>Tee-Reducer</td><td>FGP-TF750-T500</td><td>3/4" x 3/4" x 1/2"</td></tr> <tr><td>Tee-Reducer</td><td>FGP-TF1000-T750</td><td>1" x 1" x 3/4"</td></tr> <tr><td>Tee-Reducer</td><td>FGP-TF1000-T500</td><td>1" x 1" x 1/2"</td></tr> <tr><td>Tee-Reducer</td><td>FGP-TF1250-T1000</td><td>1 1/4" x 1 1/4" x 1"</td></tr> <tr><td>Tee-Reducer</td><td>FGP-TF1250-T750</td><td>1 1/4" x 1 1/4" x 3/4"</td></tr> <tr><td>Tee-Reducer</td><td>FGP-TF1250-T500</td><td>1 1/4" x 1 1/4" x 1/2"</td></tr> <tr><td>Tee-Reducer</td><td>FGP-RT-1251</td><td>1 1/4" x 1" x 1"</td></tr> <tr><td>Tee-Reducer</td><td>FGP-RT-1252</td><td>1 1/4" x 1" x 3/4"</td></tr> <tr><td>Tee-Reducer</td><td>FGP-RT-1253</td><td>1 1/4" x 1" x 1/2"</td></tr> <tr><td>Tee-Reducer</td><td>FGP-TF1500-T1250</td><td>1 1/2" x 1 1/2" x 1 1/4"</td></tr> <tr><td>Tee-Reducer</td><td>FGP-TF1500-T1000</td><td>1 1/2" x 1 1/2" x 1"</td></tr> <tr><td>Tee-Reducer</td><td>FGP-TF1500-T750</td><td>1 1/2" x 1 1/2" x 3/4"</td></tr> <tr><td>Tee-Reducer</td><td>FGP-TF1500-T500</td><td>1 1/2" x 1 1/2" x 1/2"</td></tr> <tr><td>Tee-Reducer</td><td>FGP-RT-1501</td><td>1 1/2" x 1 1/4" x 1 1/4"</td></tr> <tr><td>Tee-Reducer</td><td>FGP-RT-1502</td><td>1 1/2" x 1 1/4" x 1"</td></tr> <tr><td>Tee-Reducer</td><td>FGP-RT-1503</td><td>1 1/2" x 1 1/4" x 3/4"</td></tr> <tr><td>Tee-Reducer</td><td>FGP-RT-1504</td><td>1 1/2" x 1 1/4" x 1/2"</td></tr> <tr><td>Tee-Reducer</td><td>FGP-TF2000-T1500</td><td>2" x 2" x 1 1/2"</td></tr> <tr><td>Tee-Reducer</td><td>FGP-TF2000-T1250</td><td>2" x 2" x 1 1/4"</td></tr> <tr><td>Tee-Reducer</td><td>FGP-TF2000-T1000</td><td>2" x 2" x 1"</td></tr> <tr><td>Tee-Reducer</td><td>FGP-TF2000-T750</td><td>2" x 2" x 3/4"</td></tr> <tr><td>Tee-Reducer</td><td>FGP-TF2000-T500</td><td>2" x 2" x 1/2"</td></tr> <tr><td>Tee-Reducer</td><td>FGP-RT-2001</td><td>2" x 1 1/2" x 1 1/2"</td></tr> <tr><td>Tee-Reducer</td><td>FGP-RT-2002</td><td>2" x 1 1/2" x 1 1/4"</td></tr> <tr><td>Tee-Reducer</td><td>FGP-RT-2003</td><td>2" x 1 1/2" x 1"</td></tr> <tr><td>Tee-Reducer</td><td>FGP-RT-2004</td><td>2" x 1 1/2" x 3/4"</td></tr> <tr><td>Tee-Reducer</td><td>FGP-RT-2005</td><td>2" x 1 1/2" x 1/2"</td></tr> </tbody> </table>	Tee - <b>TracPipe</b> 1/2"	FGP-TF500-T500	1/2 x 1/2"	Tee - <b>TracPipe</b> 3/4"	FGP-TF750-T750	3/4 x 3/4"	Tee - <b>TracPipe</b> 1"	FGP-TF1000T1000	1 x 1"	Tee-Reducer	FGP-RT-501	1/2" x 3/8" x 3/8"	Tee-Reducer	FGP-RT-751	3/4" x 1/2" x 3/8"	Tee-Reducer	FGP-RT-752	3/4" x 1/2" x 1/2"	Tee-Reducer	FGP-RT-1001	1" x 3/4" x 1/2"	Tee-Reducer	FGP-RT-1002	1" x 3/4" x 3/4"	Tee-Reducer	FGP-TF750-T500	3/4" x 3/4" x 1/2"	Tee-Reducer	FGP-TF1000-T750	1" x 1" x 3/4"	Tee-Reducer	FGP-TF1000-T500	1" x 1" x 1/2"	Tee-Reducer	FGP-TF1250-T1000	1 1/4" x 1 1/4" x 1"	Tee-Reducer	FGP-TF1250-T750	1 1/4" x 1 1/4" x 3/4"	Tee-Reducer	FGP-TF1250-T500	1 1/4" x 1 1/4" x 1/2"	Tee-Reducer	FGP-RT-1251	1 1/4" x 1" x 1"	Tee-Reducer	FGP-RT-1252	1 1/4" x 1" x 3/4"	Tee-Reducer	FGP-RT-1253	1 1/4" x 1" x 1/2"	Tee-Reducer	FGP-TF1500-T1250	1 1/2" x 1 1/2" x 1 1/4"	Tee-Reducer	FGP-TF1500-T1000	1 1/2" x 1 1/2" x 1"	Tee-Reducer	FGP-TF1500-T750	1 1/2" x 1 1/2" x 3/4"	Tee-Reducer	FGP-TF1500-T500	1 1/2" x 1 1/2" x 1/2"	Tee-Reducer	FGP-RT-1501	1 1/2" x 1 1/4" x 1 1/4"	Tee-Reducer	FGP-RT-1502	1 1/2" x 1 1/4" x 1"	Tee-Reducer	FGP-RT-1503	1 1/2" x 1 1/4" x 3/4"	Tee-Reducer	FGP-RT-1504	1 1/2" x 1 1/4" x 1/2"	Tee-Reducer	FGP-TF2000-T1500	2" x 2" x 1 1/2"	Tee-Reducer	FGP-TF2000-T1250	2" x 2" x 1 1/4"	Tee-Reducer	FGP-TF2000-T1000	2" x 2" x 1"	Tee-Reducer	FGP-TF2000-T750	2" x 2" x 3/4"	Tee-Reducer	FGP-TF2000-T500	2" x 2" x 1/2"	Tee-Reducer	FGP-RT-2001	2" x 1 1/2" x 1 1/2"	Tee-Reducer	FGP-RT-2002	2" x 1 1/2" x 1 1/4"	Tee-Reducer	FGP-RT-2003	2" x 1 1/2" x 1"	Tee-Reducer	FGP-RT-2004	2" x 1 1/2" x 3/4"	Tee-Reducer
Tee - <b>TracPipe</b> 1/2"	FGP-TF500-T500	1/2 x 1/2"																																																																																																								
Tee - <b>TracPipe</b> 3/4"	FGP-TF750-T750	3/4 x 3/4"																																																																																																								
Tee - <b>TracPipe</b> 1"	FGP-TF1000T1000	1 x 1"																																																																																																								
Tee-Reducer	FGP-RT-501	1/2" x 3/8" x 3/8"																																																																																																								
Tee-Reducer	FGP-RT-751	3/4" x 1/2" x 3/8"																																																																																																								
Tee-Reducer	FGP-RT-752	3/4" x 1/2" x 1/2"																																																																																																								
Tee-Reducer	FGP-RT-1001	1" x 3/4" x 1/2"																																																																																																								
Tee-Reducer	FGP-RT-1002	1" x 3/4" x 3/4"																																																																																																								
Tee-Reducer	FGP-TF750-T500	3/4" x 3/4" x 1/2"																																																																																																								
Tee-Reducer	FGP-TF1000-T750	1" x 1" x 3/4"																																																																																																								
Tee-Reducer	FGP-TF1000-T500	1" x 1" x 1/2"																																																																																																								
Tee-Reducer	FGP-TF1250-T1000	1 1/4" x 1 1/4" x 1"																																																																																																								
Tee-Reducer	FGP-TF1250-T750	1 1/4" x 1 1/4" x 3/4"																																																																																																								
Tee-Reducer	FGP-TF1250-T500	1 1/4" x 1 1/4" x 1/2"																																																																																																								
Tee-Reducer	FGP-RT-1251	1 1/4" x 1" x 1"																																																																																																								
Tee-Reducer	FGP-RT-1252	1 1/4" x 1" x 3/4"																																																																																																								
Tee-Reducer	FGP-RT-1253	1 1/4" x 1" x 1/2"																																																																																																								
Tee-Reducer	FGP-TF1500-T1250	1 1/2" x 1 1/2" x 1 1/4"																																																																																																								
Tee-Reducer	FGP-TF1500-T1000	1 1/2" x 1 1/2" x 1"																																																																																																								
Tee-Reducer	FGP-TF1500-T750	1 1/2" x 1 1/2" x 3/4"																																																																																																								
Tee-Reducer	FGP-TF1500-T500	1 1/2" x 1 1/2" x 1/2"																																																																																																								
Tee-Reducer	FGP-RT-1501	1 1/2" x 1 1/4" x 1 1/4"																																																																																																								
Tee-Reducer	FGP-RT-1502	1 1/2" x 1 1/4" x 1"																																																																																																								
Tee-Reducer	FGP-RT-1503	1 1/2" x 1 1/4" x 3/4"																																																																																																								
Tee-Reducer	FGP-RT-1504	1 1/2" x 1 1/4" x 1/2"																																																																																																								
Tee-Reducer	FGP-TF2000-T1500	2" x 2" x 1 1/2"																																																																																																								
Tee-Reducer	FGP-TF2000-T1250	2" x 2" x 1 1/4"																																																																																																								
Tee-Reducer	FGP-TF2000-T1000	2" x 2" x 1"																																																																																																								
Tee-Reducer	FGP-TF2000-T750	2" x 2" x 3/4"																																																																																																								
Tee-Reducer	FGP-TF2000-T500	2" x 2" x 1/2"																																																																																																								
Tee-Reducer	FGP-RT-2001	2" x 1 1/2" x 1 1/2"																																																																																																								
Tee-Reducer	FGP-RT-2002	2" x 1 1/2" x 1 1/4"																																																																																																								
Tee-Reducer	FGP-RT-2003	2" x 1 1/2" x 1"																																																																																																								
Tee-Reducer	FGP-RT-2004	2" x 1 1/2" x 3/4"																																																																																																								
Tee-Reducer	FGP-RT-2005	2" x 1 1/2" x 1/2"																																																																																																								
Commercial Sized Reducer Tees	Brass Tee Fitting	 <p style="text-align: center;">Size A x B x C</p>																																																																																																								
		 <p style="text-align: center;">New Sizes</p>																																																																																																								

Serving the LP Industry

Since 1954

TABLE OF CONTENTS



1-800-457-3826



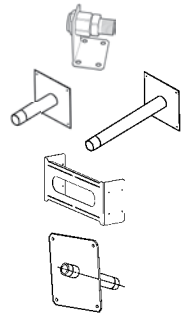
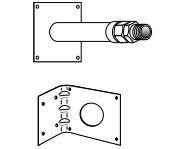

53

Building Relationships

is our utmost reward

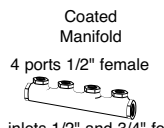
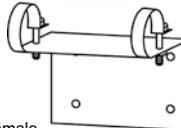
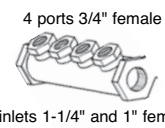
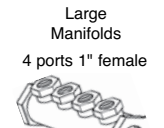
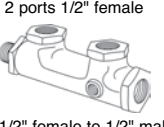
# PETROLEUM TANK CORP

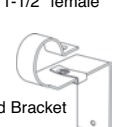
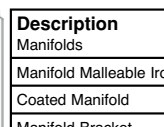
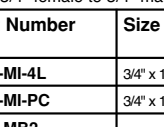
Component	<b>AutoFlare® Fittings and Accessories</b>				
Brackets and Stubs-outs		<b>Description</b>	<b>Part Number</b>	<b>Size</b>	
		<i>Fittings for TracPipe</i>			
		Key Valve Bracket	<b>FGP-KVB-375</b>	3/8"	
		Key Valve Bracket	<b>FGP-KVB-500</b>	1/2"	
		Key Valve Bracket - Reducing	<b>FGP-KVB750-500</b>	3/4" x 1/2"	
		1" x 6" Meter Term Stub-out	<b>FGP-1X6 MT</b>	1" x 6"	
		1" x 12" Meter Term Stub-out	<b>FGP-1x 12 MT</b>	1" x 12"	
		Meter Stud Bracket	<b>FGP-STUD-BRAC</b>	all	
		Appliance Stub-out	<b>FGP-ASP-500</b>	1/2" x 2-	
		Fireplace Stub-out	<b>FGP-FPT-500</b>	1/2"	
Meter Termination		6" Meter Termination 1/2"	<b>FGP-MT6-500</b>	1/2" x 6"	
		6" Meter Termination 3/4"	<b>FGP-MT6-750</b>	1/2"	
		6" Meter Termination 1"	<b>FGP-MT6-1000</b>	3/4"	
		12" Meter Termination 1/2"	<b>FGP-MT12-500</b>	1"	
		12" Meter Termination 3/4"	<b>FGP-MT12-750</b>	1/2"	
		12" Meter Termination 1"	<b>FGP-MT12-1000</b>	3/4"	
Wallbox w/Valve	 <p style="font-size: small;">Wallbox w/Valve Note: Wallbox measures 7" x 7" x 3"</p>	Meter Termination Bracket	<b>FGP-MT-BRAC</b>	1"	
		Metal Wallbox w/Valve	<b>FGP-WBTM-375</b>	3/8"	
		Metal Wallbox w/Valve	<b>FGP-WBTM-500</b>	1/2"	
		Metal Wallbox w/Valve	<b>FGP-WBTM-750</b>	3/4"	

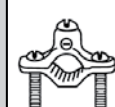
Component	Material	<b>TracPipe Accessories</b>				
Multi-port Manifolds	Coated Malleable Iron	 <p style="font-size: x-small;">Coated Manifold 4 ports 1/2" female inlets 1/2" and 3/4" female</p>	 <p style="font-size: x-small;">Manifold Bracket - For use with FGP-MI-PC only</p>	 <p style="font-size: x-small;">4 ports 3/4" female inlets 1-1/4" and 1" female</p>	 <p style="font-size: x-small;">Large Manifolds 4 ports 1" female inlets 2" and 1-1/2" female</p>	
		 <p style="font-size: x-small;">2 ports 1/2" female</p>	 <p style="font-size: x-small;">2 ports 1/2" female</p>	 <p style="font-size: x-small;">Stackable Manifold Bracket</p>		
Manifold Bracket	Galvanized Steel	 <p style="font-size: x-small;">1/2" female to 1/2" male</p>	 <p style="font-size: x-small;">3/4" female to 3/4" male</p>			
Gas Load Center	Painted Steel	 <p style="font-size: x-small;">Gas Load Center w/Manifold Bracket - For use with FGP-MI-PC only</p>	<b>Description</b>	<b>Part Number</b>	<b>Size</b>	
			Manifolds			
			Manifold Malleable Iron	<b>FGP-MI-4L</b>	3/4" x 1/2" x 1/2"(4)	
			Coated Manifold	<b>FGP-MI-PC</b>	3/4" x 1/2" x 1/2"(4)	
			Manifold Bracket	<b>FGP-MB2</b>	*	
			Stackable Manifold	<b>FGP-MI-ST-500</b>	1/2" F - M X 1/2"(2)	
			Stackable Manifold	<b>FGP-MI-ST-750</b>	3/4" F - M X 1/2"(2)	
			Stackable Manifold Bracket	<b>FGP-MB-ST</b>	fits MI-ST	
			Load Center w/Bracket	<b>FGP-LC</b>	*	
			Large Coated Manifold	<b>FGP-MI-PC-1X</b>	1-1/4" x 1" x 3/4"(4)	
Large Coated Manifold	<b>FGP-MI-PC-2X</b>	2" x 1-1/2" x 1"(4)				
Bonding Clamp	Brass		Bonding Clamp	<b>FGP-GC-1</b>	3/8", 1/2", 3/4" (TP)	1/2", 3/4", 1" (Iron pipe)
			Bonding Clamp	<b>FGP-GC-2</b>	1", 1-1/4" (TP)	1-1/4", 1-1/2", 2" (Iron pipe)
			Bonding Clamp	<b>FGP-GC-3</b>	1-1/2", 2" (TP)	2-1/2" - 4" (Iron pipe)

Serving the LP Industry

Since 1954

TABLE OF CONTENTS

1-800-457-3826

54



Building Relationships

is our utmost reward

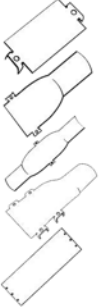

# PETROLEUM TANK CORP

Component	Material	<b>TracPipe Protection Devices</b>			
Striker Plate	Carbon Steel Hardened		<b>Description</b>	<b>Part Number</b>	<b>Size</b>
			Striker Plates		
			Quarter Striker Plate	<b>FGP-SP-025</b>	3" x 2"
			Half Striker Plate	<b>FGP-SP-050</b>	3" x 7"
			Three Quarter Striker Plate	<b>FGP-SP-075</b>	3" x 9"
			Full Striker	<b>FGP-SP-100</b>	3" x 12"
			6 1/2" X 17 Striker Plate	<b>FGP-SP-617</b>	6 1/2" X 17"

Component	Material	<b>TracPipe Protection Devices</b>			
Floppy Strip Wound Conduit	Type RW Galvanized Steel		<b>Description</b>	<b>Part Number</b>	<b>Size</b>
			Floppy Steel Conduit		
			Floppy-fits 3/8" Cut 1 ft.	<b>FGP-FPY-375CT</b>	3/4"
			Floppy-fits 1/2" Cut 1 ft.	<b>FGP-FPY-500CT</b>	1"
			Floppy-fits 3/4" Cut 1 ft.	<b>FGP-FPY-750CT</b>	1-1/4"
			Floppy-fits 1" Cut 1 ft.	<b>FGP-FPY-1000CT</b>	1-1/2"
			Floppy-fits 3/8"	<b>FGP-FPY-375-50</b>	3/4"
			Floppy-fits 1/2"	<b>FGP-FPY-500-50</b>	1"
			Floppy-fits 3/4"	<b>FGP-FPY-750-25</b>	1-1/4"
			Floppy-fits 1"	<b>FGP-FPY-1000-25</b>	1-1/2"
			Floppy-fits 1-1/4"	<b>FGP-FPY-1250-25</b>	2"
			Floppy-fits 1-1/2"	<b>FGP-FPY-1500-25</b>	2-1/2"
			Floppy-fits 2"	<b>FGP-FPY-2000-25</b>	3"
Silicone Tape	Silicone Rubber		Tape-Outdoor-Silicone	<b>FGP-915-10H-12</b>	1" x 12yd
			Tape-Outdoor-Silicone	<b>FGP-915-20H12-PO</b>	2" x 12yd
			Tape-Black	<b>FGP-915-10H-12BL</b>	1" x 12yd

*Serving the LP Industry*

*Since 1954*

**1-800-457-3826**

*Building Relationships*

*is our utmost reward*

# PETROLEUM TANK CORP

## LP GAS HOSE



LMH 0503  
LMH 05012  
LMH 05025  
LMH 05050

### HOSE ASSEMBLIES

1/2" X 3FT HOSE ASSEMBLY  
1/2" X 12FT HOSE ASSEMBLY  
1/2" X 25FT HOSE ASSEMBLY  
1/2" X 50FT HOSE ASSEMBLY

LMH 07503  
LMH 07510  
LMH 07518

3/4" X 3FT HOSE ASSEMBLY  
3/4" X 10FT HOSE ASSEMBLY  
3/4" X 18FT HOSE ASSEMBLY



LMH 012518  
LMH 020018

1 1/4" X 18FT HOSE ASSEMBLY  
2" X 18FT HOSE ASSEMBLY

LMH 0751  
LMH 01251  
LMH 01501  
LMH 02001

3/4" X 12" HOSE ASSEMBLY  
1 1/4" X 12" HOSE ASSEMBLY  
1 1/2" X 12" HOSE ASSEMBLY  
2" X 12" HOSE ASSEMBLY



LMH 1100C  
LMH 1125C  
LMH 1150C

### DELIVERY HOSE ASSEMBLIES

1" X 100FT DELIVERY HOSE  
1" X 125FT DELIVERY HOSE  
1" X 150FT DELIVERY HOSE



LMH 1405-12-12  
LMH 1404-12-12  
LMH 1404-16-16  
LMH 1405-16-16  
LMH 1405-20-20  
LMH 1404-20-20  
LMH 1404-24-24  
LMH 1405-24-24  
LMH 1404-32-32  
LMH 1405-32-32

### HOSE SWIVELS

3/4" FEMALE X FEMALE  
3/4" MALE X FEMALE  
1" MALE X FEMALE  
1" FEMALE X FEMALE  
1 1/4" FEMALE X FEMALE  
1 1/4" MALE X FEMALE  
1 1/2" MALE X FEMALE  
1 1/2" FEMALE X FEMALE  
2" MALE X FEMALE  
2" FEMALE X FEMALE



LMH PR42X18

### SMART HOSE

2" PASSIVE SHUT-OFF HOSE ASSEMBLY

*Serving the LP Industry*

*Since 1954*

TABLE OF CONTENTS

1-800-457-3826

56

*Building Relationships*

*is our utmost reward*



# PETROLEUM TANK CORP

## LP GAS HOSE REELS

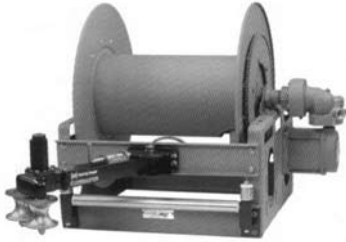

### REEL W/BOTTOM MOUNTED GUIDEMASTER

**EPBGMB-28-25-26**      **STEEL HOSE REEL W/EXPLOSION PROOF MOTOR AND GUIDEMASTER LEVEL WINDER ARM**

**SBEPBGMB-28-25-26**      **ALUMINUM HOSE REEL W/EXPLOSION PROOF MOTOR AND GUIDEMASTER LEVEL WINDER ARM**

### ALUMINUM HOSE REEL WITH PRESSED FRAME

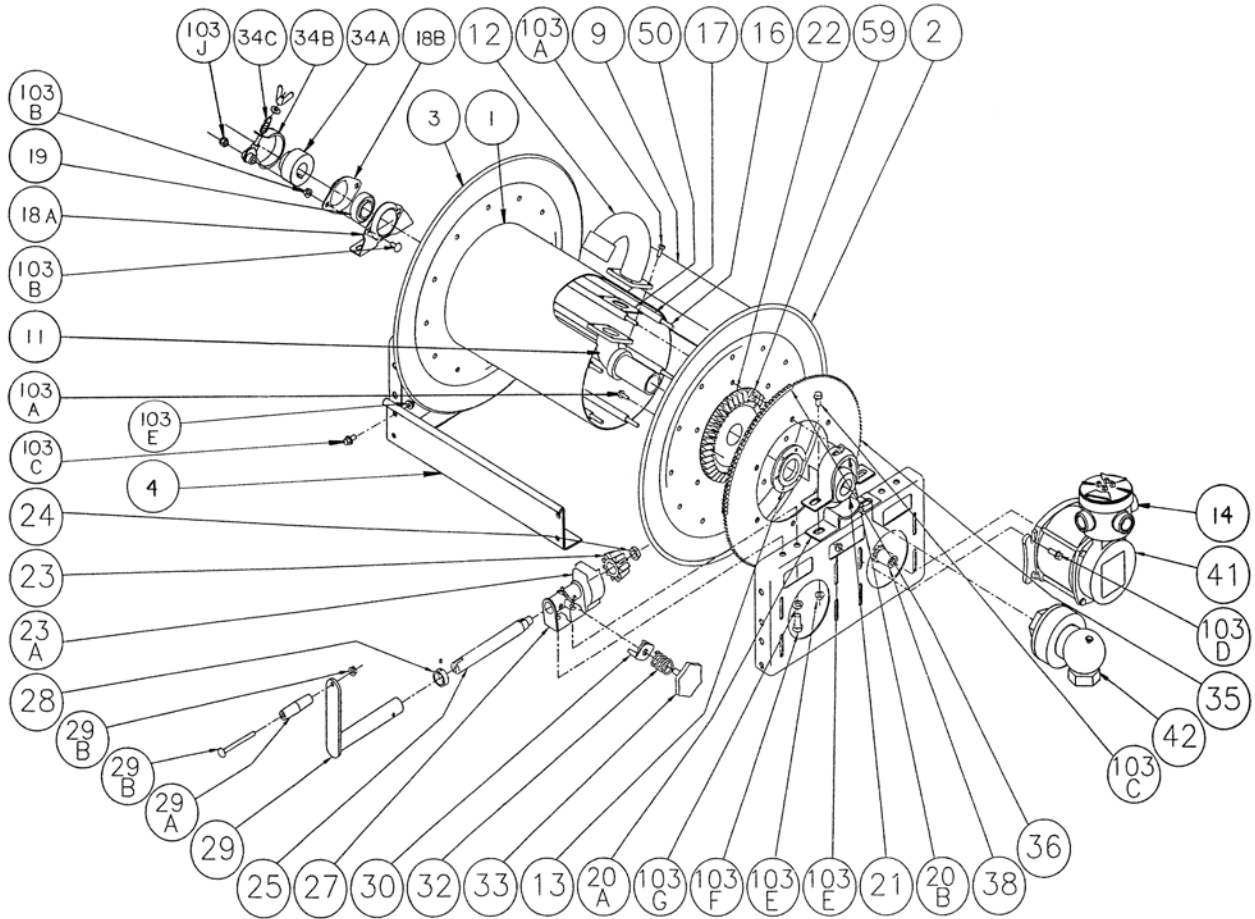

When ordering parts  
**BE SURE TO SPECIFY COMPLETE MODEL NUMBER and SERIAL NUMBER OF REEL.**  
**USE PART NUMBER!**

*Serving the LP Industry*

*Since 1954*

**TABLE OF CONTENTS**

**1-800-457-3826**

**57**

*Building Relationships*

*is our utmost reward*

# PETROLEUM TANK CORP

## LP GAS HOSE REELS

### PARTS BREAKDOWN - HOSE REEL

Item No.	Description	PART NUMBER		Quantity
		Unpolished	Polished	
1	Aluminum Drum, 10-1/2" Diameter (Specify Model)	9905.5132	9905.5132	1
2	Aluminum Front Disc, 19-20 Series	9903.0852	9903.0850	1
2	Aluminum Front Disc, 23-24 Series	9903.1152	9903.1150	1
2	Aluminum Front Disc, 25-26 Series	9903.1352	9903.1350	1
2	Aluminum Front Disc, 26-27 Series	9903.1452	9903.1450	1
2	Aluminum Front Disc, 28-29 Series	9903.1552	9903.1550	1
2	Aluminum Front Disc, 30-31 Series	9903.1652	9903.1650	1
3	Aluminum Back Disc, 19-20 Series	9903.0852	9903.0850	1
3	Aluminum Back Disc, 23-24 Series	9903.1152	9903.1150	1
3	Aluminum Back Disc, 25-26 Series	9903.1352	9903.1350	1
3	Aluminum Back Disc, 26-27 Series	9903.1452	9903.1450	1
3	Aluminum Back Disc, 28-29 Series	9903.1552	9903.1550	1
3	Aluminum Back Disc, 30-31 Series	9903.1652	9903.1650	1
4	Aluminum Frame Assembly (Up to 23-24)	9908.2300	9908.2400	1
6	Aluminum Frame Assembly (Up to 30-31)	9908.3300	9908.3400	1
11	1-1/2" Flanged Plated Hub Only (Specify Model)	9901.2846	9901.2846	1
12	1-1/2" FNPT Plated Riser Only	9901.3767	9901.3767	1
13	EH-936S Washer	9965.0018	9965.0018	2
14	Junction Box Complete	9917.0060	9917.0060	1
16	3/8"-16 Carriage Bolt w/Nut	Specify Model	Specify Model	6
17	3/8" Aluminum Spacer Pipes (Specify Model)	9904.3200	9904.3200	6
18	Back Bearing Complete	9902.1420	9902.1420	1
18A	SST Self-Aligning Pillow Block, Back	9902.2902	9902.2902	1
18B	SST Self-Aligning Bearing Holder, Back	9902.2903	9902.2903	1
19	Back Bearing Insert Only	9902.1520	9902.1520	1
20	Front Bearing Complete	9902.1620	9902.1620	1
20A	SST Bearing Holder (Bottom Strap), Front	9902.2960	9902.2960	1
20B	SST Bearing Holder (Top Strap), Front	9902.2965	9902.2965	1
21	Front Bearing Insert Only (With Grease Fitting)	9902.1700	9902.1700	1
22	Ring Gear, H-26 (Up to 25-26)	9914.0372	9914.0372	1
22	Ring Gear, H-28	9914.0382	9914.0382	1
23	Pinion Gear, H-27 (Up to 25-26)	9914.0393	9914.0393	1
23	Pinion Gear, H-29	9914.0403	9914.0403	1
23A	Gear Guard	9914.0614	9914.0614	1
24	5/8"-18 SAE Hex Nut (ESNA)	9904.5600	9904.5600	1
25	Plated Pinion Shaft (Specify Model)	9914.0252	9914.0252	1
27	Side Pinion Bearing	9914.0243	9914.0243	1
28	Collar & Set Screw	9914.0351	9914.0351	1
29	Crank Handle, H-18 Complete	9914.0014	9914.0014	1
29A	Hand Crank Handle	9914.0506	9914.0506	1
29B	Hand Crank Handle Bolt w/Nut	9914.0511	9914.0511	1
30	Brake Pad, H-3	9914.0433	9914.0433	1
32	Brake Spring, H-31	9914.0451	9914.0451	1
33	Brake Wheel	9914.0413	9914.0413	1
34A	Comet Brake Hub	9947.0038	9947.0038	1
34B	Comet Brake Strap only	9947.0091	9947.0091	1
34C	Comet Brake Tention Adjuster (Bolt, Spring, Washer, Wing Nut)	9947.0092	9947.0092	1
35	11T35 SST Disc Sprocket	9910.1322	9910.1322	1
35	138T35 Chrome Plated Disc Sprocket	9910.1424	9910.1424	1
35	180T35 Chrome Plated Disc Sprocket	9910.1527	9910.1527	1
36	Chain, #35	Specify Model	Specify Model	1
38	Motor Sprocket, 11T35 x 1-5/16	9910.1118	9910.1118	1
41	Motor, 12 Volt Explosion-Proof	9915.0003	9915.0003	1
42	1-1/2" 90 Deg. FxF Swivel Joint	9930.0531	9930.0531	1
50	Gasket	9965.0021	9965.0021	1
59	Sprocket Spacer	9954.0017	9954.0017	6
103A	5/16"-18 x 3/4" SST Hex Head Bolt	9960.0002	9960.0002	9
103B	3/8"-16 x 3/4" SST Carriage Bolt w/Nut (w/o Comet Brake)	9960.0096	9960.0096	2
103B	3/8"-16 x 2" SST Carriage Bolt w/Nut (w/Comet Brake)	9960.0097	9960.0097	1
103C	3/8"-16 x 3/4" SST Spinlock Bolt	9960.0009	9960.0009	4
103D	3/8"-16 x 1" SST Spinlock Bolt	9960.0072	9960.0072	4
103E	3/8"-16 SST Spinlock Nut	9960.0091	9960.0091	8
103F	1/2"-13 x 1" SST Hex Head Bolt	9960.0016	9960.0016	2
103G	1/2" SST Lock Washer	9960.0017	9960.0017	2
103H	1/2"-13 SST Hex Nut	9960.0018	9960.0018	2
103J	3/8"-16 SST ESNA Nut	9960.0098	9960.0098	1

*Serving the LP Industry*

*Since 1954*

**1-800-457-3826**

*Building Relationships*

*is our utmost reward*

# PETROLEUM TANK CORP

## LP GAS HOSE REELS

### GUIDEMASTER LEVEL WINDER

HAN GM700EP

LEVEL WINDER ARM ASSEMBLY

### GUIDEMASTER ARM

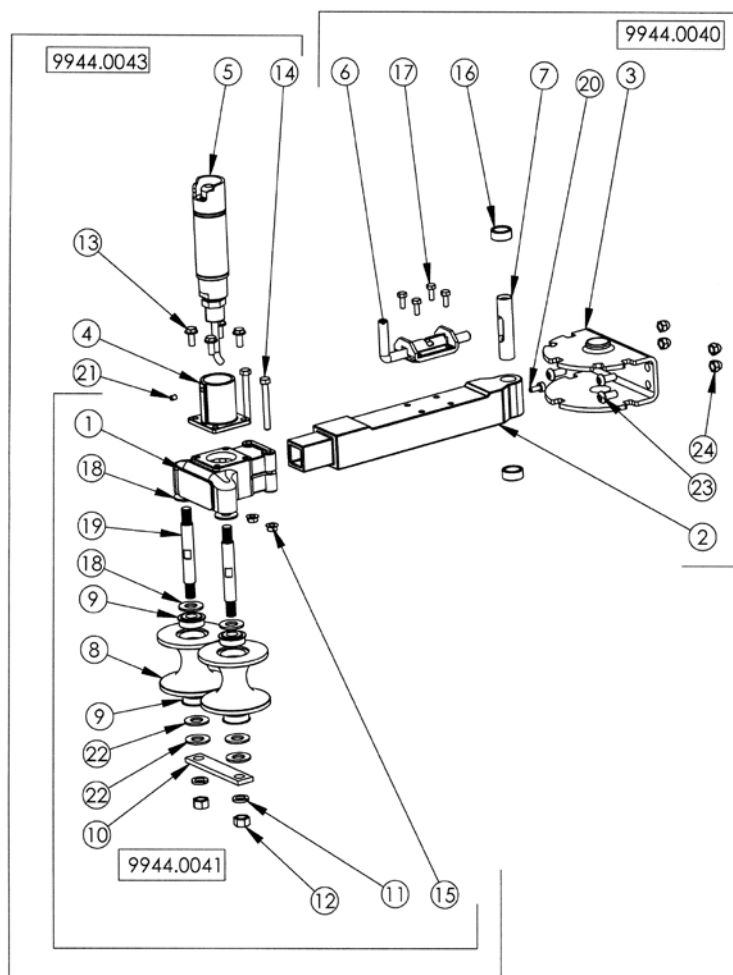

When ordering parts  
BE SURE TO SPECIFY COMPLETE MODEL NUMBER and SERIAL NUMBER OF REEL.  
**USE PART NUMBER!**

*Serving the LP Industry*

*Since 1954*

TABLE OF CONTENTS

1-800-457-3826

59

*Building Relationships*

*is our utmost reward*

# PETROLEUM TANK CORP

## LP GAS HOSE REELS

### GUIDEMASTER ARM PARTS LIST

<u>Item No.</u>	<u>Description</u>	<u>PART NUMBER</u>	<u>Quantity</u>
ISO-195-1	Roller Body Casting w/Mounting Bolts (for GM-700)	.9945.1001	1
ISO-195-2	Guide Arm Casting (for GM-700)	.9945.1002	1
ISO-195-3	Mounting Yoke with Bronze Bushings	.9945.0009	1
ISO-195-4	Switch Mounting Bracket (for GM-700)	.9917.0207	1
ISO-195-5	EPS-1 Explosion-Proof Switch	.9917.0200	1
ISO-195-6	Guidemaster Pinlock Assembly, S/S (for GM-700)	.9945.1003	1
ISO-195-7	SST Pivot Pin (with 1/4" cap screw & lock washer)	.9945.0024	1
ISO-195-8	GM-609 Roller (with 2 Pressed-in Ball Bearings)	.9945.0019	2
ISO-195-9	GM-608 Ball Bearing	.9945.0026	4
ISO-195-10	Guidemaster Bottom Roller Plate (for GM-700)	.9945.1004	1
ISO-195-11	1/2" Lock Washer	.9954.0030	2
ISO-195-12	1/2"-13 Hex Nut	.9954.0036	2
ISO-195-13	1/4"-20 x 3/4" Socket Head Cap Screw	.9945.0015	4
ISO-195-14	5/16"-24 x 2-1/2" Plated Bolt with Nut	.9945.0013	2
ISO-195-15	5/16"-24 Hex Nut	.9945.0027	2
ISO-195-16	Oil-impregnated Bronze Bushing for Yoke	.9945.0011	2
ISO-195-17	1/4"-20 x 3/4" SST Socket Head Cap Screw	.9945.0015	4
ISO-195-18	1/2" Flat Washer	.9954.0008	2
ISO-195-19	Roller Mounting Bolt (threaded) for GM-700	.9945.1005	2
ISO-195-20	1/4"-20 x 5/8" SST Socket Head Cap Screw and Lock Washer	.9945.0055	2
ISO-195-21	1/4"-20 X 5/16" Set Screw	.9958.0010	1
ISO-195-22	5/8" Flat Washer	.9954.0004	6
ISO-195-23	3/8"-16 x 3/4" Button Socket Head	.9904-9201	4
ISO-195-24	3/8"-16 Hex Acorn Nut	.9904.5290	4

## METERS



### NEPTUNE CABINET METER

NEP RL100-208A12      1" DISPENSING METER



### NEPTUNE TRUCK METER

NEP RL200-33RG02      2" TRUCK METER W/ ATC



### LIQUID CONTROLS METERS

L/C MA7GY10      2" METER W/ATC, AIR ELIMINATOR, STRAINER AND DIFFERENTIAL VALVE

*Serving the LP Industry*

*Since 1954*

**1-800-457-3826**

*Building Relationships*

*is our utmost reward*



# PETROLEUM TANK CORP

## METERS



NEP 600

METER REGISTER 1/10TH GALLONS



NEP 833

METER REGISTER W/TICKET PRINTER

### VEEDER-ROOT MECHANICAL REGISTERS



VR 789000-002

REGISTER W/ ZERO START TICKET PRINTER  
WHOLE GALLONS (FACE UP TICKET)



V/R 789002-002

REGISTER W/ ZERO START TICKET PRINTER  
1/10TH GALLONS (FACE DOWN TICKET)

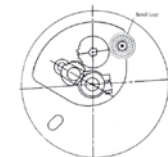

V/R GEAR PLATE

VEEDER-ROOT GEAR PLATE FOR REGISTERS

### LIQUID CONTROLS ELECTRONIC REGISTER



L/C LCR II

ELECTRONIC METERING SYSTEM W/ CAB  
MOUNTED TICKET PRINTER



L/C LCR 600

ELECTRONIC METERING SYSTEM  
W/ POS PRICING



L/C E49004

295 EPSON SLIP PRINTER

*Serving the LP Industry*

*Building Relationships*

*Since 1954*

*1-800-457-3826*

*is our utmost reward*

# PETROLEUM TANK CORP

## METERS

### LIQUID CONTROLS DATA MANAGEMENT SYSTEM

L/C-DMS

ELECTRONIC DATA MANAGEMENT SYSTEM  
FOR TRUCK MOUNTED METERING SYSTEM



*Serving the LP Industry*

*Since 1954*

TABLE OF CONTENTS

1-800-457-3826

62

*Building Relationships*

*is our utmost reward*

# PETROLEUM TANK CORP

## METERS



MID 8000

ELECTRONIC REGISTER W/ INTEGRAL TICKET  
PRINTER, CAB MOUNTED



MID SLP-100

SMART LINK, PUMP & PRINT SYSTEM



MID E-COUNT

E-COUNT ELECTRONIC REGISTER



NEP E4000

NEPTUNE ELECTRONIC REGISTER

### MID-COM ELECTRONIC REGISTERS

### NEPTUNE ELECTRONIC REGISTERS

## PUMPS



BKM LGF1E  
BKM LGF1PE  
BKM LGRLF1

1" FLANGE MOUNTING - DIRECT DRIVE, 10 GPM  
1" FLANGE MOUNTING - DIRECT DRIVE, 15 GPM  
1" FLANGE MOUNTING - DIRECT DRIVE, 15 GPM

BKM LGL1-1/4  
BKM LGL1-1/2

1 1/4" DIRECT MOUNT, 20 GPM  
1 1/2" DIRECT MOUNT, 30 GPM



BKM LGF1E-101  
BKM LGF1PE-151  
BKM LGRLF-151

1" FLANGE MOUNTING - DIRECT DRIVE, 10 GPM  
1" FLANGE MOUNTING - DIRECT DRIVE, 15 GPM  
1" FLANGE MOUNTING - DIRECT DRIVE, 15 GPM

### BLACKMER PUMPS

#### PUMP ONLY

#### PUMP ASSEMBLY W/115/230 MOTOR

*Serving the LP Industry*

*Since 1954*

*Building Relationships*

*is our utmost reward*

1-800-457-3826

# PETROLEUM TANK CORP

## PUMPS



### V-BELT DRIVE PUMP - PUMP ONLY

BKM LGLD2E      2" BASE MOUNTED PUMP, 67 GPM  
BKM LGLD3E      3" BASE MOUNTED PUMP, 133 GPM  
BKM LGLD4        4" BASE MOUNTED PUMP, 270 GPM



### PUMP ASSEMBLY - BASE MOUNTED - LESS MOTOR

BKM LGLD2E-VB    2" BASE MOUNTED PUMP, 67 GPM  
BKM LGLD3E-VB    3" BASE MOUNTED PUMP, 133 GPM  
BKM LGLD4-VB      4" BASE MOUNTED PUMP, 270 GPM



### FLANGE MOUNTED PUMP - TRANSPORT & BOBTAIL

BKM TLGLF3C      3" FLANGE, 2" FNPT X 2" FNPT, 93 GPM



BKM TLGLF4C      4" FLANGE, 3" FNPT X DUAL 2" FNPT



### BYPASS VALVES

BKM BV1 1/4      1 1/4" BYPASS VALVE  
BKM BV2            2" BYPASS VALVE

*Serving the LP Industry*

*Since 1954*

TABLE OF CONTENTS

1-800-457-3826

64

*Building Relationships*

*is our utmost reward*



# PETROLEUM TANK CORP

## PUMPS

### CORKEN PUMPS

#### CORKEN CORO-FLO PUMPS

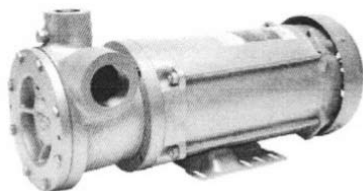

**COR C10DD2A SM-10** 1 1/4" FNPT X 1" FNPT, CLOSE COUPLED PUMP W/ 3/4 HP, CONTINUOUS DUTY MOTOR, & MOTOR MOUNTED STARTER SWITCH



**COR C12ED2A SM-20** 1 1/2" FNPT X 1" FNPT, CLOSE COUPLED PUMP W/ 1 HP, CONTINUOUS DUTY MOTOR, & MOTOR MOUNTED STARTER SWITCH



**COR Z2000** 2" DELIVERY TRUCK PUMP



**COR Z3200** 3" FLANGE MOUNTED TRUCK PUMP



**COR Z4200** 4" FLANGE MOUNTED TRUCK & TRANSPORT PUMP

## DECALS & PLACARDS



**DSP 980-326** 2" X 12" RED & WHITE CONSPICUITY STRIPES  
**DSP 981-326 ROLL** 2" X 150FT ROLL, RED & WHITE CONSPICUITY



**DSP C37G** EXCHANGE CYLINDER CHECK LIST

*Serving the LP Industry*

*Building Relationships*

*Since 1954*

**1-800-457-3826**

*is our utmost reward*

# PETROLEUM TANK CORP

## DECALS & PLACARDS



DSP G-1075  
DSP P-1075  
DSP V-1075

1075 LP GAS PLACARD  
1075 PLACARD  
VINYL 1075 FLAMMABLE VAPOR DECAL

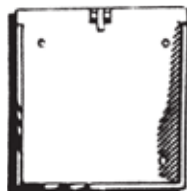

DSP MPH-69  
L/M CG126FO

PLACARD HOLDER  
FLIP PLACARD UNIT



DSP NFPA-704-100  
DSP NFPA-704-3

DECAL  
1-4-0 PROPANE STORAGE TANK DECAL, 15" X 15"

DSP V-704-1  
DSP V-704-3

1-4-0 DIAMOND, 7 1/2" X 7 1/2" DECAL  
1-4-0 DIAMOND, 15" X 15" DECAL

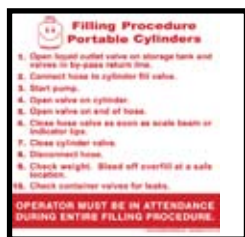

DSP P-121

FILLING PROCEDURE PLACARD



DSP P-123

SAFETY IS YOU PLACARD



DSP P-81

EMERGENCY SHUT-OFF PULL PLACARD

*Serving the LP Industry*

*Since 1954*

TABLE OF CONTENTS

1-800-457-3826

66

*Building Relationships*

*is our utmost reward*

# PETROLEUM TANK CORP

## DECALS & PLACARDS



DSP P-82

EMERGENCY SHUT-OFF PUSH PLACARD



DSP P-83

SHIPPING PLACARD

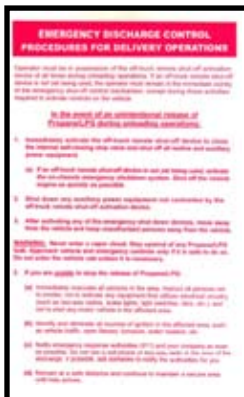

DSP PRS-EOP1

EMERGENCY PROCEDURES, LAMINATED CARD



DSP PRS-EOP2

EMERGENCY PROCEDURES DECAL



DSP S-22B

RR XING, 4" X 36" RED DECAL

*Serving the LP Industry*

*Building Relationships*

*Since 1954*

1-800-457-3826

*is our utmost reward*

# PETROLEUM TANK CORP

## DECALS & PLACARDS



DSP S-22C

RR XING, 8" X 12" RED DECAL



DSP S-29

REFLECTIVE CONSPICUITY TAPE, 4" X 36"



DSP V-1203

VINYL 1203 FLAMABLE LIQUID DECAL

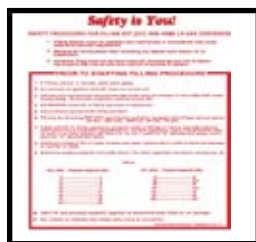

DSP V-123

VINYL SAFETY IS YOU



DSP V-134

VINYL EMERGENCY SHUT, 2 1/2" X 6"



DSP V-23A  
DSP V-23C  
DSP V-23D  
DSP V-49

VINYL, 6" NO SMOKING DECAL  
2", NO SMOKING DECAL  
1", NO SMOKING DECAL  
8", NO SMOKING DECAL



DSP V-24B  
DSP V-24BB  
DSP V-24C  
DSP V-48

4", FLAMMABLE DECAL  
3", FLAMMABLE DECAL  
2", FLAMMABLE DECAL  
9", FLAMMABLE DECAL



DAP V-26A  
DSP V-26B

NO SMOKING SHUT-OFF  
NO SMOKING/OPEN FLAMES, 12" X 18"



DSP V-28A  
DSP V-28B  
DSP V-28BB  
DSP V-28C  
DSP V-97A

6" PROPANE DECAL  
4" PROPANE DECAL  
3" PROPANE DECAL  
2" PROPANE DECAL  
2FT X 4FT PROPANE FS/VINYL

*Serving the LP Industry*

*Since 1954*

TABLE OF CONTENTS

1-800-457-3826

68

*Building Relationships*

*is our utmost reward*

# PETROLEUM TANK CORP

## DECALS & PLACCARDS



DSP V-30

TANK FILL PROCEDURES

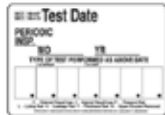

11223344K  
 55667788T  
 99000VPILU

DSP V-31

ANNUAL INSPECTION DECAL

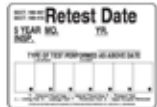

11223344K  
 55667788T  
 99000VPILU

DSP V-32

RE-TEST 5-YEAR INSPECTION DECAL

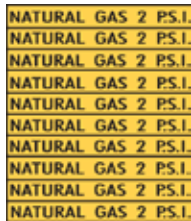

DSP V-40

NATURAL GAS 2 PSI DECAL



DSP V-45

ASSORTED VALVE LABELS



DSP V-55

WARNING DECAL - 20# CYLINDER



DSP V-56R

WARNING DECAL

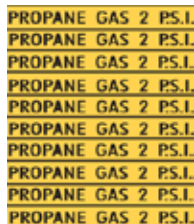

DSP V-62

PROPANE GAS 2PSI



DSP V-66

NQT DECAL

*Serving the LP Industry*

*Building Relationships*

*Since 1954*

*1-800-457-3826*

*is our utmost reward*

# PETROLEUM TANK CORP

## DECALS & PLACCARDS

**GAS GAS GAS**

**LIQUID  
LIQUID  
LIQUID  
LIQUID  
LIQUID**

**VAPOR  
VAPOR  
VAPOR  
VAPOR  
VAPOR**

DSP V-85

GAS TAPE

DSP V-90  
DSP V-90-5

1" X 4" LIQUID DECAL  
1" X 4" LIQUID DECAL, 5-PART

DSP V-91  
DSP V-91-5

1" X 4" VAPOR DECAL  
1" X 4" VAPOR DECAL, 5-PART

## PAINT

### KLINGER PAINT



KLG 03-00029  
KLG 03-00030  
KLG 03-00032

130 ALUMINUM PAINT (1 GAL)  
130 ALUMINUM PAINT (5 GAL)  
230 GAL ALUMINUM PAINT (1 GAL)

KLG 03-00748  
KLG 03-00749

11017 BRIGHT WHITE TK PAINT (5 GAL)  
11017 BRIGHT WHITE TK PAINT (1 GAL)

KLG 03-00821  
KLG 03-00924  
KLG 00415

MS URETHANE TAR (U-G COATING) (1 GAL)  
14022 LT GREY FD PRIMER (1 GAL)  
PENETROL (1 GAL)

### ACCESSORIES

KLG 03-00500  
KLG 11380  
KLG 14827  
KLG 14829  
KLG 14844  
KLG BB  
KLG 002002

EMPTY 5-GAL BUCKET W/LID  
WIRE BRUSH W/SCRAPER  
5-GAL ROLLER GRID  
48" WOOD EXT. POLE  
9" HVY DUTY ROLLER FRAME  
BUCKET BONNET  
9" 3/4 NAP ROLLER COVER

*Serving the LP Industry*

*Since 1954*

TABLE OF CONTENTS

1-800-457-3826

*Building Relationships*

*is our utmost reward*

# PETROLEUM TANK CORP

## LIGHTING



### BETTS LIGHTING

PETCO CARRIES A FULL LINE OF TRUCK LIGHTING, BOTH STANDARD AND LED INCLUDING STOP/TURN/TAIL, RUNNING LIGHTS, WORK LIGHTS, AND REFLECTORS



### BACK UP ALARMS

VEL 697097

SMALL BACK UP ALARM

## PTO DRIVE SHAFT



PETCO MANUFACTURERS ALL DRIVE SHAFT ASSEMBLIES AS A KIT - CONSULT OUR PARTS DEPARTMENT FOR PROPER ASSEMBLIES

## POWER TAKE-OFFS

PETCO OFFERS BOTH THE CHELSEA AND MUNCIE POWER TAKE-OFFS BASED ON THE TRANSMISSION APPLICATION



CHELSEA POWER TAKE-OFF



MUNCIE POWER TAKE-OFF

*Serving the LP Industry*

*Since 1954*

*Building Relationships*

*is our utmost reward*

1-800-457-3826



# PETROLEUM TANK CORP

## CABLE CONTROLS



B/P R38D6X06  
B/P R38D6X15  
B/P R38D6X25

### PTO CABLES

6 FT CABLE ASSEMBLY  
15 FT CABLE ASSEMBLY  
25 FT CABLE ASSEMBLY



B/P VCGTX25  
B/P VCGTHO  
B/P 516

### THROTTLE CABLE

25 FT VERNIER HEAVY DUTY CABLE ASSEMBLY  
VERNIER CABLE HEAD ONLY  
5/16" BRASS BARREL HEAD THROTTLE STOP

## SWITCHES



VEL 032037

FLIP TYPE AIR SWITCH



VEL 034042

LOW PRESSURE AIR SWITCH



VEL 090108

TOGGLE SWITCH

## CHOCK BLOCKS



B/P WC765  
B/P WC1267  
B/P WC1588

### ALUMINUM WHEEL CHOCKS

SMALL ALUMINUM WHEEL CHOCK  
MEDIUM ALUMINUM WHEEL CHOCK  
LARGE ALUMINUM WHEEL CHOCK



B/P WCB186

BRACKET FOR THE WC1267 WHEEL CHOCK

## FIRE EXTINGUISHERS



BFP 411

20 LB. ABC MILTI PURPOSE DRY CHEMICAL  
FIRE EXTINGUISHER

BFP 810

BRACKET FOR 20 LB. FIRE EXTINGUISHER

*Serving the LP Industry*

*Since 1954*

TABLE OF CONTENTS

1-800-457-3826

72

*Building Relationships*

*is our utmost reward*



# PETROLEUM TANK CORP

## TOOL BOXES



B/P 1701300  
B/P 1701303  
B/P 1705105  
B/P 1705110

### ALUMINUM TOOL BOXES

18" X 18" X 24" ALUMINUM TOOL BOX  
18" X 18" X 30" ALUMINUM TOOL BOX  
18" X 18" X 36" ALUMINUM TOOL BOX  
18" X 18" X 48" ALUMINUM TOOL BOX

## MIRRORS



VEL 705332

### WEST COAST MIRRORS

7" X 16" HEATED, STAINLESS STEEL, W/MARKER LIGHT



VEL 708525

7" X 16" HEATED, STAINLESS STEEL



VEL 708444

8 1/2" CONVEX, STAINLESS, W/ "L" BRACKET



VEL 708446

8 1/2" CONVEX, BLACK POWDER COATED  
W/ "L" BRACKET



VEL 708476

6" CONVEX, STAINLESS, W/UNIVERSAL BRACKET

*Serving the LP Industry*

*Building Relationships*

*Since 1954*

*1-800-457-3826*

*is our utmost reward*

# PETROLEUM TANK CORP

## MIRRORS



VEL 708478

### SPOT MIRRORS

6" CONVEX, STAINLESS, W/ "L" BRACKET



VEL 747053

### HEATED MIRROR KIT

SWITCH KIT, HEATED MIRROR HEADS

## GAS LIGHTERS



CAM GM3  
CAM GM3X  
CAM GM3XE  
CAM GM10

### IGNITION LIGHTERS

15" IGNITION PIPE, APPLIANCE LIGHTER  
15" ALL PURPOSE FLEX LIGHTER  
26" ALL PURPOSE FLEX LIGHTER  
15" ALL PURPOSE, REFILLABLE LIGHTER



CAM GM12X

20" IGNITION PIPE, APPLIANCE LIGHTER



CAM GM9

### IGNITION LIGHTERS

2 PACK MULTI PURPOSE LIGHTER, 15" O.A.L.

*Serving the LP Industry*

*Since 1954*

TABLE OF CONTENTS

1-800-457-3826

74

*Building Relationships*

*is our utmost reward*

# PETROLEUM TANK CORP

## TOOLS & ACCESSORIES



BRM 8651  
BRM 8652  
BRM 8653

BLUE WIRE CONNECTORS  
ORANGE WIRE CONNECTORS  
YELLOW WIRE CONNECTORS



VEL 056107

SOLDERLESS TERMINAL KIT



BRM 6608  
BRM 6609

1/4" ANCHOR KIT  
5/16" ANCHOR KIT



BRM 13297

TORCH



CRN PS45

HAND CLEANER



BRM 17903

GOJO HAND CLEANER

*Serving the LP Industry*

*Since 1954*

TABLE OF CONTENTS

1-800-457-3826

75

*Building Relationships*

*is our utmost reward*

# PETROLEUM TANK CORP

## TOOLS & ACCESSORIES



BRM 14834 FLASH LIGHT



BRM 7215 LANTERN W/ BATTERY



GRA 5T516 FIRST AID KIT



NOR 13204 BOOSTER CABLES



WTS R-KIT REFLECTIVE TRIANGLES



BRM 19824 GREASE CARTRIDGE, 14 OZ.



BRM 19823 TWO PACK, 3 OZ CARTRIDGE



BRM 400019 MACHINE OIL



L/M DAR996 ACCIDENT REPORT KIT  
L/M DAR97 CAMERA

*Serving the LP Industry*

*Since 1954*

**TABLE OF CONTENTS**

**1-800-457-3826**

76

*Building Relationships*

*is our utmost reward*

# PETROLEUM TANK CORP

## TOOLS & ACCESSORIES



BRM 0170 EXTEND-A-MATCH



BRM 9068 EXTEND-A-MIRROR



BRM 18109 EXTEND-A-MAGNET



CRN FA12 PENETRATING OIL



NOR 23855 AMBER SAFETY GLASSES



NOR 19909 GREY SAFETY GLASSES



BRM 13142 WASP & HORNET SPRAY



NOR 14600 DOG REPELLANT SPRAY



NOR 21862 RAIN SUITS (L, XL, 2XL)

*Serving the LP Industry*

*Since 1954*

**TABLE OF CONTENTS**

**1-800-457-3826**

**77**

*Building Relationships*

*is our utmost reward*

# PETROLEUM TANK CORP

## TOOLS & ACCESSORIES



NOR 3500 WORK GLOVES



E/W 31-791L WINTER TUF-DUK PROPANE GLOVES



NOR 2789 NITRILE ROUGH SAFETY GLOVES



CHA CM-18 18" MASONRY DRILL BITS (3/8", 1/2", 5/8", 3/4", 7/8")



BRM 14929 DEAD BLOW HAMMER



BRM 15171 4 1/2" CHANNEL LOCK PLIERS  
BRM 15172 6 1/2" CHANNEL LOCK PLIERS  
BRM 15173 10" CHANNEL LOCK PLIERS  
BRM 15174 12" CHANNEL LOCK PLIERS



ROT 70441 6" ADJUSTABLE WRENCH  
ROT 70442 8" ADJUSTABLE WRENCH  
ROT 70443 10" ADJUSTABLE WRENCH  
ROT 70444 12" ADJUSTABLE WRENCH  
ROT 79445 15" ADJUSTABLE WRENCH



B/P 01045 1" X 12FT RATCHET TIE DOWN  
B/P 01050 2" X 22FT RATCHET TIE DOWN



NOR 9690 VISE GRIPS



NOR 9692 4" LONG NOSE VISE GRIPS  
NOR 9693 6" LONG NOSE VISE GRIPS

*Serving the LP Industry*

*Since 1954*

**TABLE OF CONTENTS**

**1-800-457-3826**

*Building Relationships*

*is our utmost reward*

# PETROLEUM TANK CORP

## TOOLS & ACCESSORIES



ROT 70150	8" STEEL PIPE WRENCH
ROT 70151	10" STEEL PIPE WRENCH
ROT 70152	12" STEEL PIPE WRENCH
ROT 70153	14" STEEL PIPE WRENCH
ROT 70154	18" STEEL PIPE WRENCH
ROT 70155	24" STEEL PIPE WRENCH

## CRANE TRUCK TIE-DOWN STRAPS & SLINGS



L/A EN30 x 3	3 FT BRIDLE STRAP W/HOOKS
L/A EN30 X 6	6 FT BRIDLE STRAP W/HOOKS
L/A EN30 X 10	10 FT BRIDLE STRAP W/HOOKS
L/A EN30 X 11	11FT BRIDLE STRAP (SLING)



L/A ETS-5	5 FT E-TRACK STRAP
L/A ETS-12	12 FT E-TRACK STRAP
L/A ETS-16	16 FT E-TRACK STRAP
L/A ETS-20	20 FT E-TRACK STRAP



L/A MM150	RATCHET CHAIN HOIST
-----------	---------------------



L/A TS12	12 FT TRAILER STRAP
L/A TS18	18 FT TRAILER STRAP
L/A TS27	27 FT TRAILER STRAP
L/A TS27H	RATCHET STRAP W/HOOK

## TANK CRADLE



PET TC500	TANK CRADLE
-----------	-------------

## CYLINDER TRAILER



## STRADDLE TRAILER

PET LTT-2M	TRAILER W/ (2) MANUAL HOISTS
PET LTT-2E	TRAILER W/(2) ELECTRIC HOISTS

*Serving the LP Industry*

*Building Relationships*

*Since 1954*

*1-800-457-3826*

*is our utmost reward*



# PETROLEUM TANK CORP

## PUMP STATIONS



PET PSC10-LCMS STEEL DISPENSING CABINET W/PUMP, METER, SCALES

PET PSC10-LCS STEEL DISPENSING CABINET W/ PUMP & SCALES ONLY



PET PSC12-ALCMS ALUMINUM DISPENSING CABINET W/PUMP, METER & SCALES

PET PSC10-ALCS ALUMINUM DISPENSING CABINET W/PUMP & SCALES ONLY

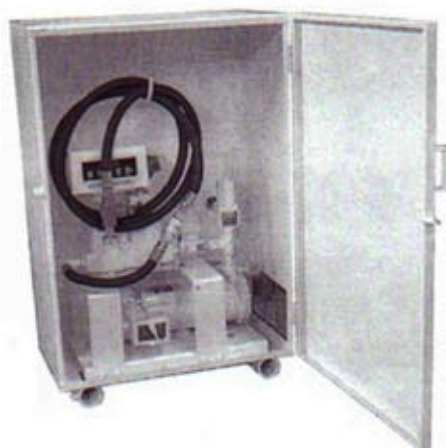

PETCO PS1 SMALL STEEL DISPENSING CABINET (OPTIONAL WITH PUMP AND METER)

PETCO APS1 SMALL ALUMINUM DISPENSING CABINET (OPTIONAL WITH PUMP AND METER)



B/P 1124

## PORTABLE SCALES

PORTABLE BEAM SCALE, 1000# CAPACITY INCLUDES 900# OF COUNTER WEIGHTS

*Serving the LP Industry*

*Since 1954*

TABLE OF CONTENTS

1-800-457-3826

*Building Relationships*

*is our utmost reward*

# PETROLEUM TANK CORP

## REMOTE SHUT-DOWN

### SINGLE FUNCTION CONTROL SYSTEMS

BAS ASK-D 100F	FOR REGO "FLOWMATIC" INTERNAL VALVES
BAS ASK-D 100A	FOR AIR OPERATED TANK VALVES - INCLUDES HD AIR SOLENOID, W/PREWIRED ENGINE KILL RELAY
BAS ASK-D 100ACS	FOR CABLE OPERATED INTERNAL VALVES THAT HAVE AVAILABLE AIR SUPPLY W/ PRE-WIRED ENGINE KILL RELAY & AIR ACTUATOR
BAS ASD-D 100ECS	FOR CABLE OPERATED VALVES (GASOLINE & PROPANE ENGINE WITHOUT AIR BRAKES) COMPLETE WITH ELECTRIC ACTUATOR

### MULTI-CHANNEL CONTROL SYSTEMS



BAS ASK-D 200F	TWO FUNCTION SYSTEM FOR REGO "FLOWMATIC" VALVE
BAS ASK-D 200A	TWO FUNCTION INCLUDES ONE PRE-WIRED AIR SOLENOID, AND ENGINE KILL
BAS ASK-D 200H	TWO FUNCTION FOR HOSE UNWIND, & EMERGENCY STOP FOR FLOWMATIC - INCLUDES ENGINE KILL & HOSE REEL MOTOR REVERSER MODULE W/50 AMP BREAKER
BAS ASK-D 200AH	TWO FUNCTION FOR HOSE UNWIND, & EMERGENCY STOP FOR PNEUMATIC INTERNAL VALVE - INCLUDES ENGINE KILL & HOSE REEL REVERSER MODULE W/ 50 AMP BREAKER
BAS ASK-D 300F	THREE FUNCTION COMPLETE WITH THREE FUNCTION TRANSMITTER & RECEIVER - THREE PRE-WIRED OUTPUTS INCLUDING ENGINE KILL RELAY
BAS ASK-D 300A	THREE FUNCTION INCLUDES ONE PRE-WIRED AIR SOLENOID AND ENGINE KILL RELAY
BAS ASK-D 3002A	THREE FUNCTION INCLUDES TWO PRE-WIRED AIR SOLENOIDS & ENGINE KILL RELAY
BAS ASK-D 4002AH	FOUR FUNCTION INCLUDES TWO PRE-WIRED AIR SOLENOIDS, ENGINE KILL RELAY, & HOSE REEL REVERSER SOLENOIDS WITH 50 AMP BREAKER IN POLYCARBONATE BOX
BAS QUERY	5-MINUTE AUTOMATIC SHUT-OFF

*Serving the LP Industry*

*Since 1954*

TABLE OF CONTENTS

1-800-457-3826

81

*Building Relationships*

*is our utmost reward*

# **WE HAVE YOU COVERED**

*Marshall Gas Regulators*

*Constab Mech. Fittings*

*Pigtails*

*Polyethylene Pipe & Fittings*

*Black Pipe Fittings*

*Trinity Tanks*

*Worthington Cylinders*

*Brass Fittings*

*TracPipe CSST & Fittings*

*Dormont Flex Connectors*

*Annodeless Risers*

**FROM  
INSTALLATION**

*Coated/Non-Coated Copper Tubing*

*Tank Valves*

*Tank Gauges*

**TO**

**MAINTENANCE**

*Methanol*

*Klinger Tank Paint*

**FOR  
ALL**



**YOUR  
NEEDS**

**1-800-457-3826**

*Gloves*

*Gauges & Test Sets*

*Tubing Cutters & Benders*

*Flaring Tools*

*Fusion Tools*

**TO**

**TOOLS &  
ACCESSORIES**

*Leak Detector*

*Cathodic Protection*

*Tie-Down Straps & Saddles*

*Pipe Dope*

*Cyl. Valve Removal Wrenches  
& Vises*

*Hannay Hose Reels*

*Liquid Controls Meters*

*Dispensing Units*

*Blackmer Pumps*

*Corken Pumps*

*Actaris Meters*

**TO**

**DELIVERY**

*Marshall Excelsior  
(Loading Valves, Swivels & Adaptors)*

*(Liquid Withdrawal Valves)*

*Actaris Meters*

*Delivery Hoses & Assemblies*

*Electronic Registers (LC, Actaris, Mid Com, Veeder-Root)*